

User's Manual

SHIMANO

EP801 / EP600

Check our website for the latest manuals.

<https://si.shimano.com>



Contents

IMPORTANT NOTICE	3
Important safety information	4
SHIMANO STEPS battery management systems and compatibility	8
Notice	9
Regular inspections before riding the bicycle	12
Booklet structure	13
SHIMANO STEPS characteristics	14
Before you ride	17
Quick guide	18
Names of parts	26
Specifications	28
When a problem occurs	29
Error indication	29
Troubleshooting.....	29

IMPORTANT NOTICE



- Contact the place of purchase or a distributor for information on installation, adjustment, and replacement of the products which are not found in the user's manual. A dealer's manual for professional and experienced bicycle mechanics is available on our website (<https://si.shimano.com>).
- Please observe the appropriate rules and regulations of the country, state or region in which you conduct your business as a dealer.
- The Bluetooth[®] word mark and logos are registered trademarks owned by the Bluetooth SIG, Inc. and any use of such marks by SHIMANO INC. is under license.

Other trademarks and trade names are those of their respective owners.

For safety, be sure to read this user's manual thoroughly before use, follow it for correct use, and store it so that it can be referenced at any time.

The following instructions must be observed at all times in order to prevent personal injury and physical damage to equipment and surroundings.

The instructions are classified according to the degree of danger or damage which may occur if the product is used incorrectly.

	DANGER	Failure to follow the instructions will result in death or serious injury.
	WARNING	Failure to follow the instructions could result in death or serious injury.
	CAUTION	Failure to follow the instructions could cause personal injury or physical damage to equipment and surroundings.

Important safety information

DANGER

■ Handling the battery

- Do not deform, modify, disassemble, or apply solder directly to the battery.
Doing so may cause leakage, overheating, bursting, or ignition.
- Do not leave the battery near sources of heat such as heaters, and do not heat the battery or throw it into a fire.
Doing so may cause bursting or ignition.
- Do not throw or subject the battery to strong shock.
Doing so may cause overheating, bursting, or ignition.
- Do not place the battery into fresh water or sea water, and do not allow the battery terminals to get wet.
Doing so may cause overheating, bursting, or ignition.
- When charging the specified battery, use the specified battery charger for charging and observe the specified charging conditions.
Doing otherwise may cause overheating, bursting, or ignition.
- If the battery does not become fully charged even 2 hours after the designated charging time, immediately unplug the battery from the electrical outlet and contact the place of purchase.
Doing otherwise may cause overheating, bursting, or ignition.
Refer to the battery charger user's manual for the designated charging time of the battery.

WARNING

- Do not disassemble or modify the product. This may cause the product to not operate correctly, and you may suddenly fall and be seriously injured.
- Riding precautions
- Do not pay excessive attention to the cycle computer display while riding.
Doing so may result in an accident.
 - Be sufficiently familiar with how to start the power assisted bicycle before riding on busy streets.
You may start the bicycle unexpectedly, which may result in an accident.
 - Make sure that the light is on before riding.
- Safety precautions
- Be sure to remove the battery and charging cable before wiring or attaching parts to the bicycle.
Failure to do so may cause an electric shock.
 - When charging the battery while it is installed on the bicycle, do not move the bicycle.
The battery charger's power plug may come loose and not be fully inserted into the electrical outlet, resulting in a risk of fire.
 - Do not touch the drive unit when it has been continuously used for a long period of time.
The surface of the drive unit becomes hot and could cause burns.
 - Clean the chain with an appropriate chain cleaner regularly.
Intervals between maintenance depend on the use and riding circumstances.
 - Never use alkali- or acid-based solvents such as rust cleaners.
If those solvents are used the chain might break and cause serious injury.
 - Be sure to follow the instructions provided in the manuals when installing the product.
Only use SHIMANO genuine parts. If a component or replacement part is incorrectly assembled or adjusted, it can lead to component failure and cause the rider to lose control and crash.
- Handling the battery
- If any liquid leaking from the battery gets into your eyes, immediately wash the affected area thoroughly with clean water such as tap water without rubbing your eyes, and seek medical attention immediately.
If this is not done, the battery liquid may damage your eyes.
 - Do not recharge the battery in wet or very humid places, or outdoors.
A fire, ignition, overheating, or electric shock may occur.
 - Do not insert or remove the plug while it is wet.
Doing so may result in electric shock. If the inside of the plug is wet, dry it thoroughly before inserting it.

Important safety information

- Do not use the battery if it has any noticeable scratches or other external damage.
If this is not observed, bursting, overheating or problems with operation may occur.
- Do not use the battery if leakages, discoloration, deformation, or any other abnormalities occur.
If this is not observed, bursting, overheating or problems with operation may occur.
- Do not use the battery outside its operating temperature ranges.
If a battery is used or stored in temperatures which are outside these ranges, fire, injury or problems with operation may occur. The operating temperature ranges are given below:
 - (1) During discharge: -10 - 50°C
 - (2) During charging: 0 - 40°C

CAUTION

■ Riding precautions

- Observe the instructions in the manual for the bicycle in order to ride safely.

■ Safety precautions

- Never modify the system.
Doing so may cause a system error.
- Periodically check the battery charger and adapter, particularly the cord, plug, and case, for any damage.
If the charger or adapter is broken, do not use it until it has been repaired.
- Use the product under the supervision of someone responsible for safety, and only as instructed.
Do not allow anyone (including children) with reduced physical, sensual, or mental capacity, or those without experience or knowledge, to use the product.
- Do not allow children to play near the product.

■ Handling the battery

- Do not leave the battery in a place exposed to direct sunlight, inside a vehicle on a hot day, or other hot places.
This may result in battery leakage.
- If any leaked fluid gets on your skin or clothes, wash it off immediately with clean water.
The leaked fluid may damage your skin.
- Keep out of reach of children.
- Handle components with both hands.
Failure to do so may cause the components to fall and break or cause injury.
- If an error occurs during the battery discharge or charge operation, immediately stop using it and check the user's manual.
If you are not sure, consult the place of purchase or a distributor.
- Do not touch the battery when it is at a high temperature.
Doing so may cause a burn.
- Do not touch the battery for an extended period of time when its temperature has increased.
Doing so may cause a low-temperature burn.

SHIMANO STEPS battery management systems and compatibility

There are two generations of the SHIMANO STEPS battery management system: first generation and second generation (Gen.2).

This manual only describes products compatible with Gen.2.

With some exceptions, first-generation and Gen.2 products of SHIMANO STEPS components are not compatible with each other. For details, refer to the compatibility information on the SHIMANO product website (<https://productinfo.shimano.com/#/com>).

The Gen.2 battery and compatible battery mount are marked "Gen.2" as indicated in the figure.

Location of terminals

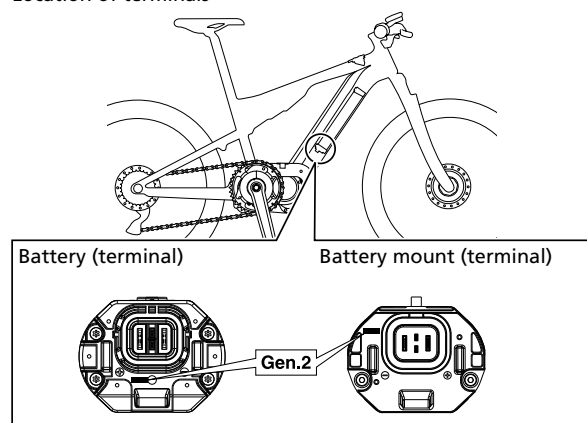

Notice

■ Riding precautions

- Avoid wearing clothing that may get caught in a chain or wheel, as this may cause an accident.

■ Safety precautions

- If any malfunction or trouble occurs, consult the place of purchase nearest you.
- For any questions regarding methods of installation and maintenance, please contact your place of purchase.
- Be sure to attach dummy plugs to any unused E-TUBE ports.
- For installation and adjustment of the product, consult the place of purchase.
- The components are designed to be fully waterproofed to withstand wet weather riding conditions; however, do not deliberately place them into water.
- Do not clean the bicycle in a high-pressure wash. If water gets into any of the components, operating problems or rusting may result.
- Do not turn the bicycle upside down. There is a risk of damage to the cycle computer and switch unit.
- Handle the components carefully, and avoid subjecting them to strong shock.
- Although the bicycle still functions as a normal bicycle even when the battery is removed, the light will not turn on if it is connected to the electric power system. Be aware that using the bicycle under these conditions will be considered non-observance of the road traffic laws in Germany.
- Contact the place of purchase for updates of the component software. The most up-to-date information is available on the SHIMANO website.
- Products are not guaranteed against natural wear and deterioration from normal use and aging.
- For maximum performance we highly recommend SHIMANO lubricants and maintenance products.

■ Handling the battery

- When charging the battery while it is mounted on the bicycle, be careful of the following:
 - Before charging, check that there is no water on the charging port or the plug of the battery charger.
 - Check that the battery mount is locked before charging.
 - Do not remove the battery from the battery mount while charging.
 - Do not ride with the battery charger mounted.
 - Close the cap on the charging port when not charging.
 - Fix the bicycle in place when charging, so that it does not tip over.
- The number written on the key of the battery mount is necessary when purchasing a spare key. Store it

carefully.

- When carrying the assist bicycle in a car, remove the battery from the bicycle and place it on a stable surface in the car.
- Before connecting the battery, make sure that there is no water collecting in the area where the battery will be connected (connector), and that it is not dirty.
- It is recommended to use a SHIMANO genuine battery. If using a battery from another company, be sure to read the owner's manual thoroughly prior to use.

■ Connection and communication with PC

The PC linkage device is needed to connect the bicycle to a PC. Using E-TUBE PROJECT Professional enables you to perform a range of tasks, such as customizing individual components or the entire system, or updating firmware.

- PC linkage device: SM-PCE02
- E-TUBE PROJECT Professional: PC application
- Firmware: Software inside each component

■ Connection and communication with smartphone

Components that support Bluetooth[®] LE are required to connect the bicycle to a smartphone. Using E-TUBE PROJECT Cyclist enables you to perform a range of tasks, such as customizing individual components or the system, or updating firmware.

- E-TUBE PROJECT Cyclist: Application for smartphones
- Firmware: Software inside each component

■ Care and maintenance

- Do not use the thinners or harsh solvents to clean the products. Such substances may damage the surface. When cleaning the products, use a cloth moistened with a neutral detergent diluted with water.
- The chainrings and sprockets should be periodically washed with a neutral detergent. In addition, cleaning the chain with neutral detergent and lubricating it can be an effective way of extending the life of the chainrings, sprockets, and the chain.
- Use a damp, well wrung out cloth, when cleaning the battery and plastic cover.

■ Assist

- The proper level of assistance cannot be achieved unless the proper settings have been made (proper adjustment of the chain tension, etc.), so consult with the place of purchase.

■ Open source software

- The open source software used in this product is available at the following URL:



<https://si.shimano.com/compliance/oss>

■ Labels

- Some of the important information contained in this manual is also indicated on the battery charger label.

Disposal information for countries outside the European Union



This symbol is only valid within the European Union. Follow local regulations when disposing of used batteries. If you are not sure, consult the place of purchase or a distributor.



This symbol on your product, literature, or packaging reminds you that this product must be taken to separate collection at the end of its working life. Do not dispose of this product as unsorted municipal waste but instead take it for recycling. By ensuring the product is disposed correctly, you will help to prevent potential negative consequences for the environment and human health. For info on your nearest recycling point, check with your local waste authority.

FCC compliance information

This device complies with part 15 of the FCC Rules.

Operation is subject to the following two conditions:

(1) This device may not cause harmful interference, and (2) this device must accept any interference received, including interference that may cause undesired operation.

NOTICE: This equipment has been tested and found to comply with the limits for a Class B digital device, pursuant to part 15 of the FCC Rules. These limits are designed to provide reasonable protection against harmful interference in a residential installation. This equipment generates, uses and can radiate radio frequency energy and, if not installed and used in accordance with the instructions, may cause harmful interference to radio communications. However, there is no guarantee that interference will not occur in a particular installation. If this equipment does cause harmful interference to radio or television reception, which can be determined by turning the equipment off and on, the user is encouraged to try to correct the interference by one or more of the following measures:

- Reorient or relocate the receiving antenna.
- Increase the separation between the equipment and receiver.
- Connect the equipment into an outlet on a circuit different from that to which the receiver is connected.
- Consult the dealer or an experienced radio/TV technician for help.

Regular inspections before riding the bicycle

Before riding the bicycle, check the following items. If any problems are found, consult your place of purchase or a distributor.

- Does the drivetrain perform gear shifting smoothly?
- Is there any looseness or damage in the component parts?
- Are the components securely installed to the frame/handlebar/stem, etc.?
- Do any abnormal noises occur while riding?
- Is there sufficient charge remaining in the battery?

Avoid wearing clothing that may get caught in a chain or wheel, as this may cause an accident.

Booklet structure

SHIMANO STEPS user's manuals are split among several booklets, as described below.

Be sure to read these user's manuals thoroughly before use, and follow them for correct use. Store the user's manuals so that they can be referenced at any time.

The latest user's manuals are available on our website (<https://si.shimano.com>).

Name	Details
SHIMANO STEPS User's Manual	This is the basic user's manual for SHIMANO STEPS. It contains the following content: <ul style="list-style-type: none"> • SHIMANO STEPS quick guide • Basic operations when riding • How to operate assist bicycles that use flat handlebars, such as city, trekking, or MTB type bicycles
SHIMANO STEPS User's Manual for Drop Handlebar Bicycles (separate booklet)	This booklet describes how to operate assist bicycles that use a drop handlebar and are controlled using dual control levers. This should be read along with the SHIMANO STEPS User's Manual.
SHIMANO STEPS Special Battery and Parts User's Manual (Gen.2)	It contains the following content: <ul style="list-style-type: none"> • How to charge and handle the SHIMANO STEPS special battery • How to attach and remove the SHIMANO STEPS special battery to the bicycle • How to read the battery LEDs when charging or during an error
SHIMANO STEPS Cycle Computer User's Manual (clamp band type / bracket installation type / switch unit integrated type)	It contains the following content: <ul style="list-style-type: none"> • Method for configuring settings via the main body buttons and switch unit • Wireless communication method (supported models only)
Switch Unit User's Manual (with LED indicator function / without LED indicator function)	This is the assist switch and shift switch user's manual. It describes switch unit handling and operations.
Satellite System ON / OFF Switch User's Manual	It describes the handling and operations of the satellite system ON / OFF switch.

SHIMANO STEPS characteristics

- **Pursuing the bicycle-like feel**
With its lightweight and compact design, the drive unit is meant to provide a bicycle-like feel with reduced operation noise and powerful output.
- **Improved customization**
Automatic gear shifting is compatible with both the assist profile and the rear derailleur, enabling a wide range of customization.
- **Compatibility with a wide range of bicycle categories**
From sport riding and city cycling to cargo bicycles designed for transporting goods, assist bicycles can be used for many applications.

Assist profile

On assist bicycles with cycle computers, you can select from two assist profiles, [BASIC] and [Fine tune], that determine the riding comfort. In addition, by connecting to E-TUBE PROJECT, you can perform a wider range of customization than before.

[BASIC]

Select the level of assistance from three modes according to riding conditions. One of the following two combinations is set by default:

- [BOOST] / [TRAIL] / [ECO]: A combination of assist modes for sport riding.
- [HIGH] / [NORMAL] / [ECO]: A combination of assist modes for comfortable riding in urban settings.

Assist mode	Level of assistance	Main application
[BOOST] / [HIGH]	Increase	Precipitous mountain roads and steep slopes
[TRAIL] / [NORMAL] * ₁	Intermediate	Gentle ascending slopes and level ground
[ECO]	Decrease	Long distance riding on level ground, level parks with signals

*₁ Depending on the cycle computer, [NORM] is displayed.

TECH TIPS

- When the battery level is low, the level of assistance is automatically reduced to increase the maximum traveling distance.
- When battery levels are unstable, or when assist power is not required, you can turn assist mode to [OFF].

[Fine tune]

The riding comfort of the assist bicycle is determined by the relationship between the force applied to the pedals and the drive unit output, and the maximum output of the drive unit. [Fine tune] supports a wide range of riding conditions with up to 15 levels of settings.

- The number of settings registered by default depends on the bicycle.
- The settings and gear position can be customized in E-TUBE PROJECT.

Example of five-level [Fine tune] configuration

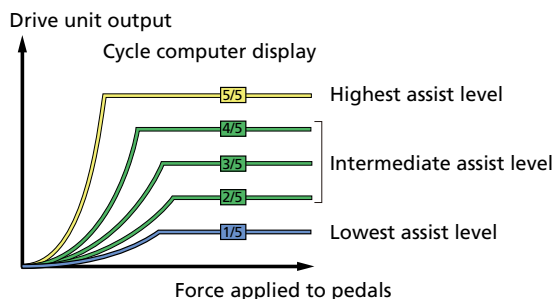

TECH TIPS

- The drive unit's maximum output may be capped by the bicycle manufacturer depending on national and regional laws and regulations.

Automatic gear shifting

This product provides automatic gear shifting not only with conventional internal geared hubs, but also for bicycles with rear derailleurs.

In addition, you can expand the automatic gear shifting settings to configure the following detailed settings in E-TUBE PROJECT. You can register up to two combinations of these settings, and use the shift switch to change

between them according to riding conditions.

[Auto shifting while pedaling]	Turn automatic gear shifting while pedaling ON or OFF. When turned ON, you can use the switch unit to change to automatic gear shifting.
[AUTO FREE SHIFT]	Turn automatic gear shifting while coasting (not pedaling) ON or OFF.
[MANUAL FREE SHIFT]	Select whether or not to enable manual gear shifting while coasting.
[Shift timing] * ₁	Set the gear shifting timing during automatic gear shifting. This timing is based on cadence.
[Riding scene]	Select between [MTB] or [Pavement] style of riding. Automatic gear shifting characteristics will change depending on the style.
[Climbing response]	Configure the automatic gear shifting response when climbing hills.
[Start mode] * ₂	Automatically shift to the set gear position when starting to pedal from a stop.

*₁ Can also be configured via the cycle computer.

*₂ Di2 internal geared hub only.

Before you ride

You cannot use the battery immediately after shipment.

The battery can be used after charging it with the designated battery charger.

Be sure to charge it before use. The battery can be used when the LED on it turns on.

Please read the " SHIMANO STEPS Special Battery and Parts User's Manual " for how to charge and handle the battery.

Quick guide

This section explains how to handle an assist bicycle that has had SHIMANO STEPS installed.

TECH TIPS

Depending on the assist bicycle used, the installed battery, cycle computer, and switch unit may differ from what is listed here. Refer to the " SHIMANO STEPS Special Battery and Parts User's Manual ", "SHIMANO STEPS Cycle Computer User's Manual" (clamp band type / bracket installation type / switch unit integrated type) and "Switch Unit User's Manual (with LED indicator function / without LED indicator function)."

1. Charge the battery.

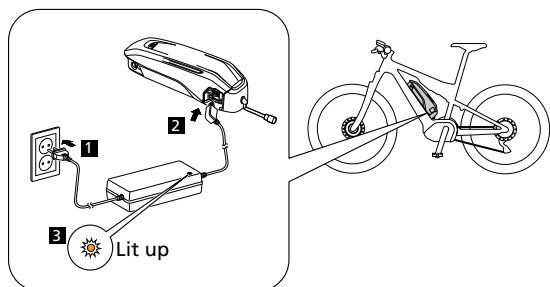

Example of external type battery

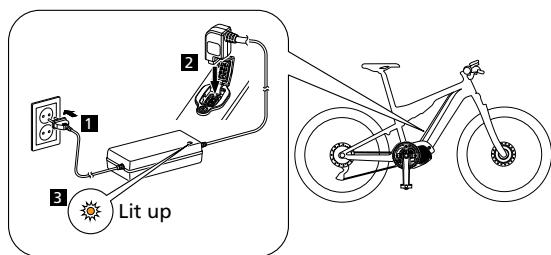

Example of built-in type battery

* According to the assist bicycle, the location of the charging port may be different from the one shown in the figure.



 Lit up	Charging
 Flashing	Charge error

2. Turn the power ON.

To turn OFF the power, repeat this procedure.

Wait a while before pressing the power button when turning the power ON again after the power has been turned OFF.

Example of external type battery

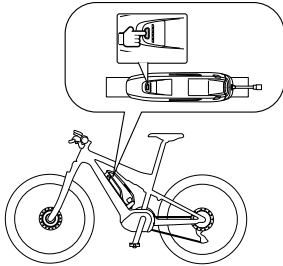

Example of built-in type battery

* According to the assist bicycle, the location of the power button may be different from the one shown in the figure.

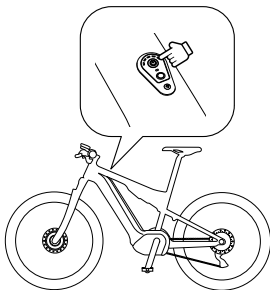

Example of 3-switch type switch unit (handlebar left side)

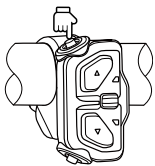

3. Select assist mode.

- When the power is turned off, the assist mode resets to [OFF].
- The below shows the display for the [BASIC] assist profile. For the [Fine tune] assist profile display, refer to the user's manuals for your cycle computer and switch unit.

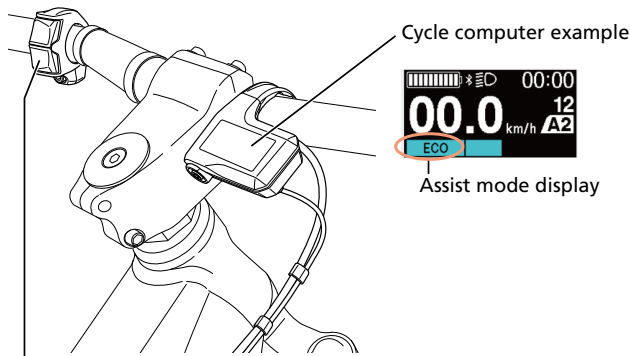

Switch unit

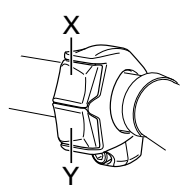

2-switch type

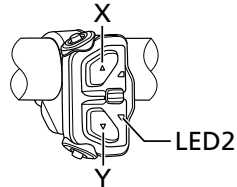

3-switch type

LED2	Assist mode display
OFF	[OFF]
Y ▲	▼ X
Light blue	[ECO]
▲	▼
Green	[TRAIL] / [NORMAL]
▲	▼
Yellow	[BOOST] / [HIGH]

TECH TIPS

- Depending on the assist bicycle, you change the assist mode with the function switch of the satellite system ON/OFF switch. Refer to " Satellite System ON/OFF Switch User's Manual " for details.

4. Get on the bicycle and start riding.

Turn the pedals to start assist.

CAUTION

Be sure to learn the brake control characteristics and other characteristics. Brake handling may vary slightly depending on the bicycle you are using.

5. Turn the power OFF and park your bicycle when you arrive at your destination.

Making walking and pushing the bicycle easy (walk assist)

SHIMANO STEPS has a function where assist works even when you are walking and pushing the assist bicycle.

- Depending on the region of use, you may not be able to use it due to the laws of the region. In this case, the operations described here are disabled.
- This function cannot be used with bicycles that do not have assist switch installed.

1. Stop and switch to walk assist mode.

Press and hold Y on the assist switch (left side of the handlebar) until it reaches the following state:

- Cycle computer: [WALK] is displayed
- 3-switch type: LED2 lights up blue

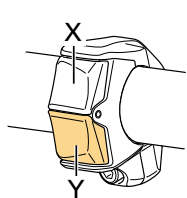

2-switch type

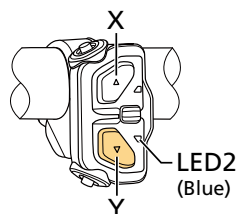

3-switch type

Cycle computer example

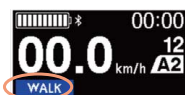

TECH TIPS

- If nothing is done for one minute after switching to walk assist mode, it will switch back to the assist mode that was selected before switching.

2. Carefully push the bicycle while pressing Y again.

The drive unit operates while Y is pressed to assist you in pushing the bicycle.

When the drive unit is operating, the LED and screen displays change as shown in the figure.

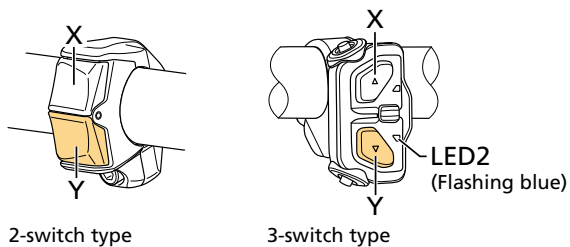

Cycle computer example



NOTICE

Walk assist operates at a maximum of 6 km/h. Be careful because the bicycle starts moving just by pressing Y.

TECH TIPS

- During electronic gear shifting, the level of assistance of walk assist and speed are controlled by the current gear position.

3. Exit walk assist mode.

Press the button (X button) on the upper side of the assist switch (left side of the handle).

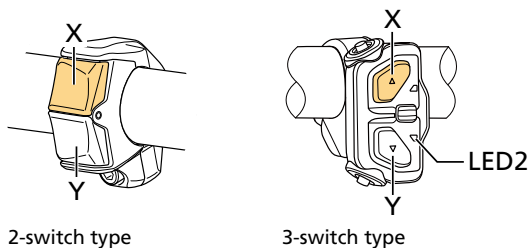

Automatic and manual gear shifting

Depending on the assist bicycle used, you may be able to switch between automatic and manual gear shifting.

- Automatic gear shifting: Automatically shifts gears based on riding conditions.
- Manual gear shifting: This is standard electronic gear shifting. Gears are shifted by operating the shift switch.

1. Switch between automatic and manual gear shifting.

Press A on the shift switch (right side of the handlebar).

Shifting switches between automatic and manual gear shifting as shown below.

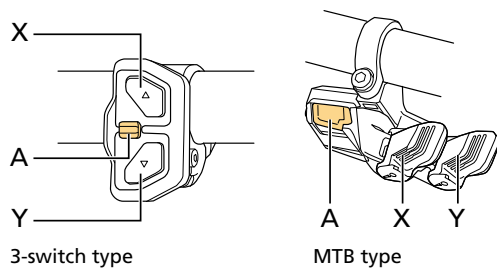

When there is one automatic gear shifting setting



When there are two automatic gear shifting settings

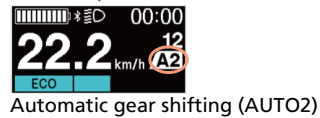
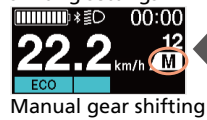

TECH TIPS

- The display will differ depending on the model of cycle computer. Refer to the user's manual of your cycle computer.

Names of parts

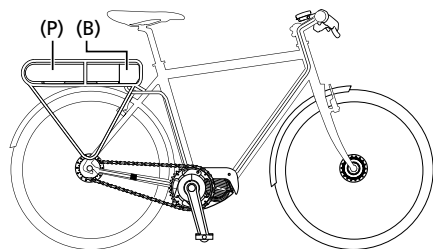
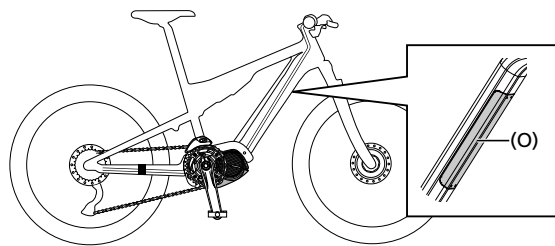
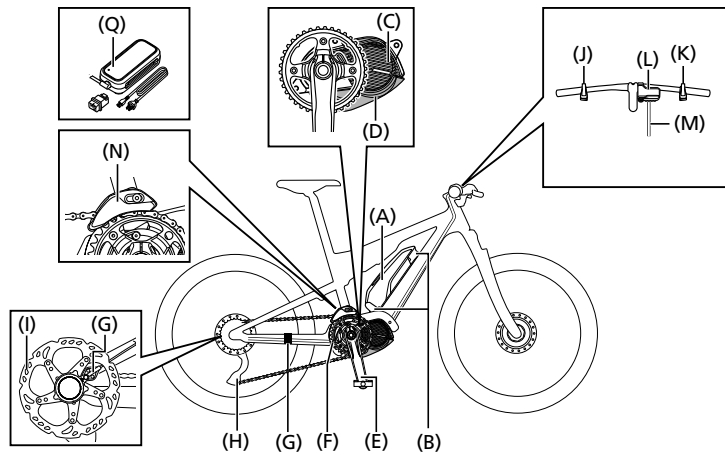

Names of parts

(A)	External type battery * ₁
(B)	Battery mount * ₂
(C)	Drive unit
(D)	Drive unit cover (left side and bottom side)
(E)	Crank arm
(F)	Chainring unit
(G)	Speed sensor * ₃
(H)	Shifting unit * ₄
(I)	Disc brake rotor
(J)	Switch unit (assist switch)
(K)	Switch unit (shift switch) or shift lever
(L)	Cycle computer
(M)	Electric wire
(N)	Chain device
(O)	Built-in type battery
(P)	Rear carrier type battery
(Q)	Battery charger

*₁ Depending on the assist bicycle, the battery may be installed at a location different from the position specified in the figure.

*₂ The battery mount of the built-in type battery is installed inside the frame.

*₃ It is attached to one of the two locations specified in the figure.

*₄ Electronic gear shifting: Di2 rear derailleur or motor unit + Di2 internal geared hub

Mechanical gear shifting: rear derailleur or internal geared hub

Specifications

Operating temperature range: During discharge	-10 - 50°C
Operating temperature range: During charging	0 - 40°C
Storage temperature	-20 - 70°C
Storage temperature (battery)	-20 - 60°C
Charging voltage	100 - 240 V AC
Charging time	Refer to the " SHIMANO STEPS Special Battery and Parts User's Manual ."
Battery type	Lithium-ion battery
Nominal capacity	Refer to the " SHIMANO STEPS Special Battery and Parts User's Manual ."
Rated voltage	36 V DC
Drive unit type	Midship
Motor type	Brushless DC
Rated drive unit power	250 W

* The maximum speed that provides assist is set by the bicycle manufacturer, but may vary depending on the conditions under which the bicycle is used.

When a problem occurs

Error indication

When a problem occurs

Error indication

For details on error/warning codes, check the latest versions below:



<https://si.shimano.com/error>

Troubleshooting

The FAQ for SHIMANO STEPS can be accessed with the following:



<https://bike.shimano.com/faq/STP0A>

SHIMANO



SHIMANO NORTH AMERICA BICYCLE, INC.
One Holland, Irvine, California 92618, U.S.A. Phone: +1-949-951-5003

SHIMANO EUROPE B.V.
High Tech Campus 92, 5656 AG Eindhoven, The Netherlands Phone: +31-402-612222

MADISON (A DIVISION OF H.YOUNG (OPERATIONS) LTD)
Roebuck Way, Knowlhill, Milton Keynes, Buckinghamshire, MK5 8HL, United Kingdom

SHIMANO INC.
3-77 Oimatsu-cho, Sakai-ku, Sakai City, Osaka 590-8577, Japan