

BESV

Experience Amazing

Pedelec / e-bike

City • Trekking • MTB

According to EN 15194:2018-11

Translation of the pedelec original instruction manual

City pedelec parts

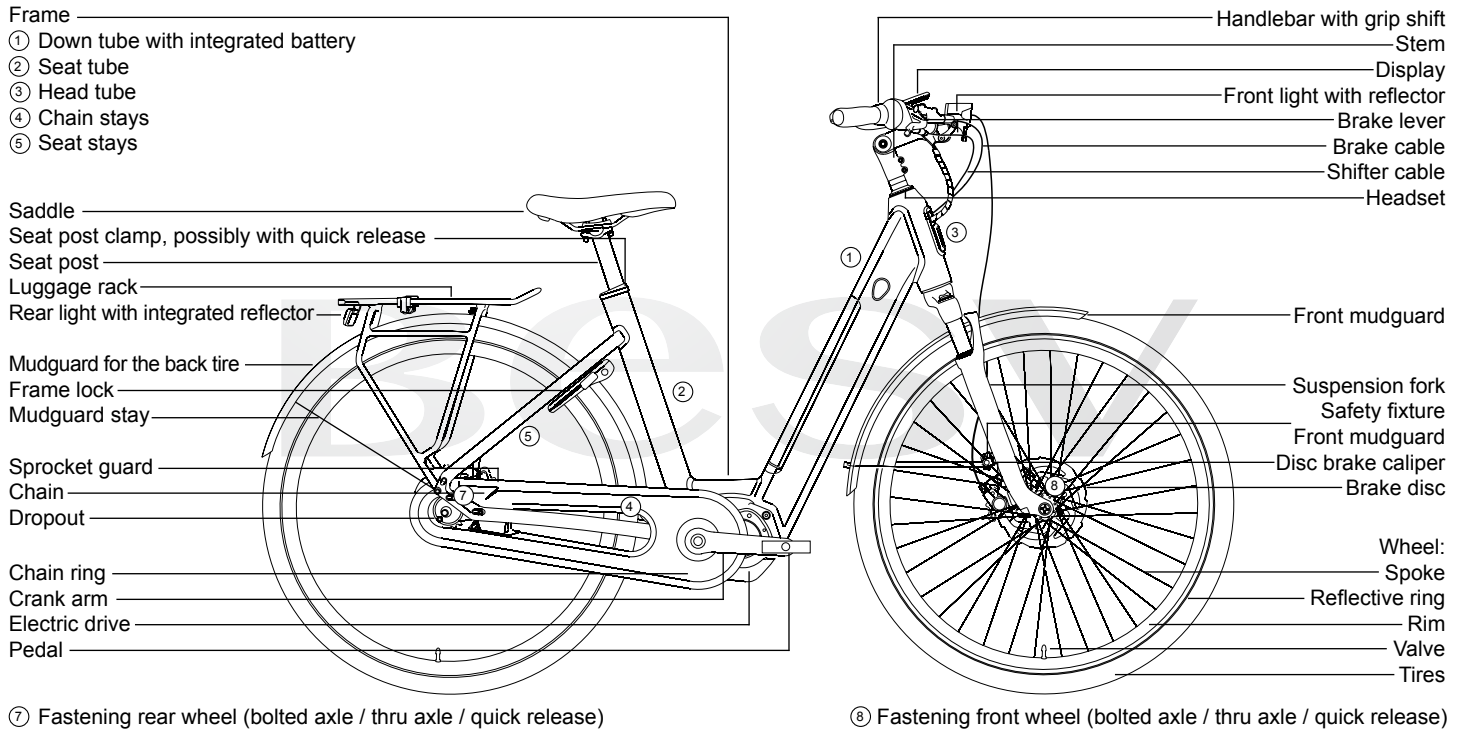

The enclosed images show the standard commercial pedelec models. The pedelec you have purchased may look somewhat different. This manual describes pedelecs in the following categories: City/trekking and MTB. This instruction manual only applies to the pedelec mentioned on the envelope with which it was issued.

Trekking pedelec parts

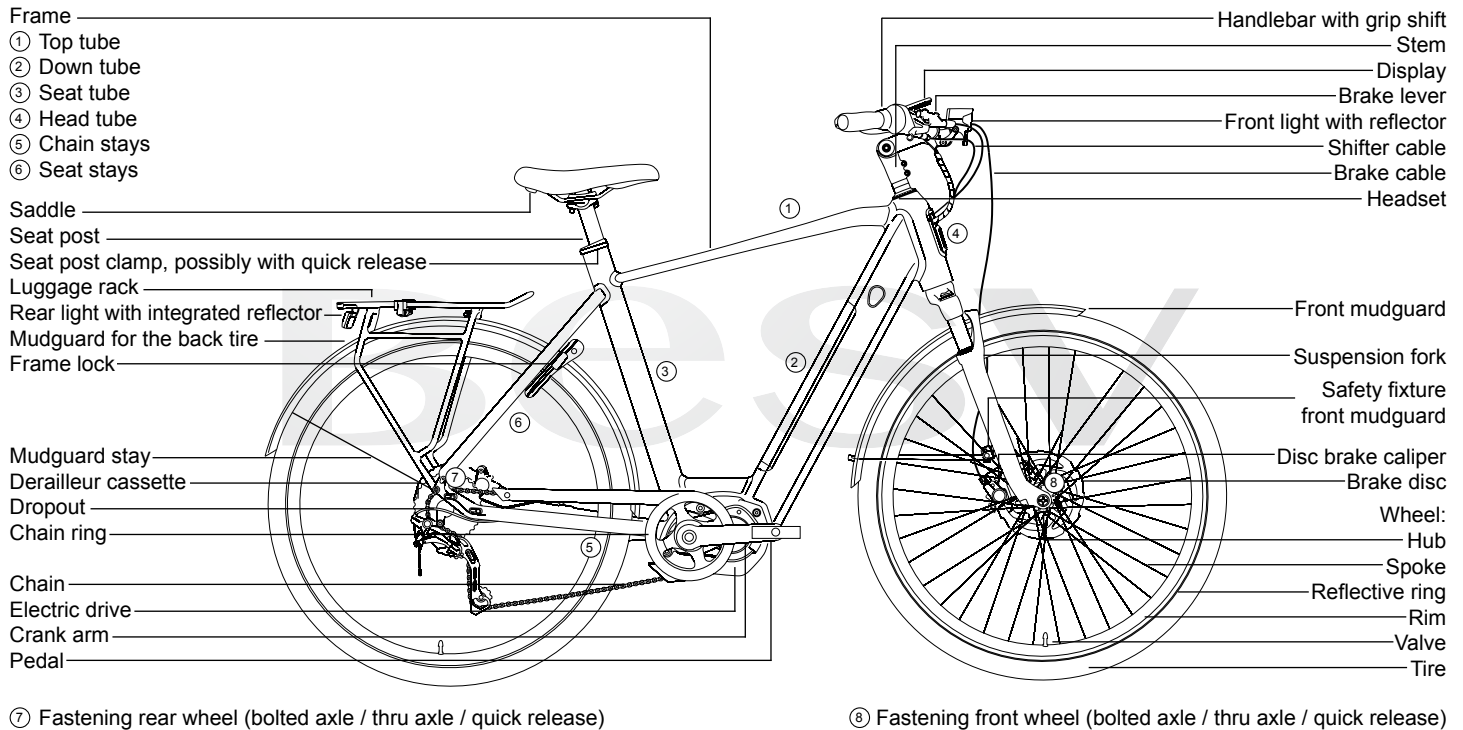

The enclosed images show the standard commercial pedelec models. The pedelec you have purchased may look somewhat different. This manual describes pedelecs in the following categories: City/trekking and MTB. This instruction manual only applies to the pedelec mentioned on the envelope with which it was issued.

MTB pedelec parts

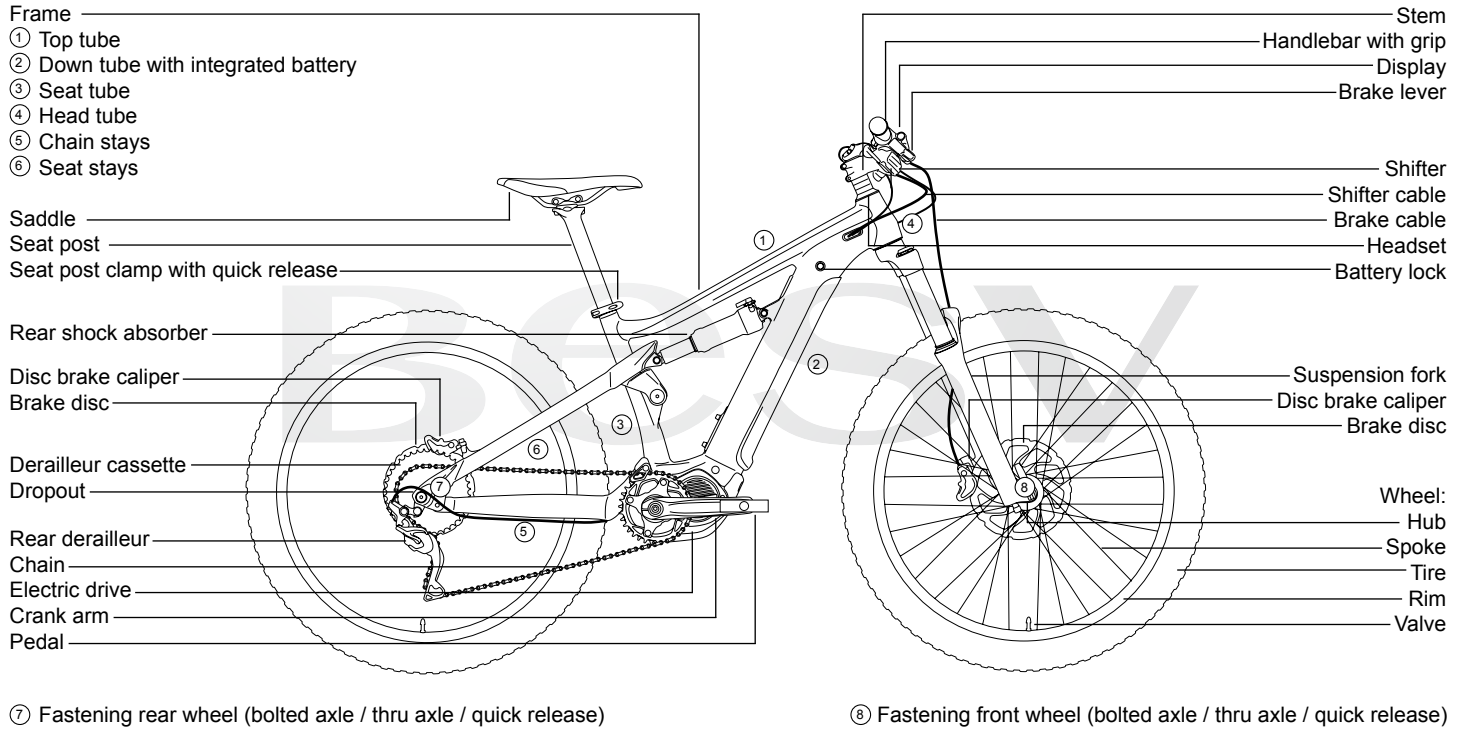

The enclosed images show the standard commercial pedelec models. The pedelec you have purchased may look somewhat different. This manual describes pedelecs in the following categories: City/trekking and MTB. This instruction manual only applies to the pedelec mentioned on the envelope with which it was issued.

Content

City pedelec parts	A	Drive unit	18	Inspection plan	42
Trekking pedelec parts	B	Maintenance and care	18	Inspection timeframes and assignments	43
MTB pedelec parts	C	Wear and tear and warranty	19	Lubricant schedule	44
Safety instructions	2	Adjusting the pedelec to the rider	19	Bolted connections	45
Introduction	3	Using quick release levers and through axles	20	Loose accessories	46
For your safety	4	Through axles	20	Loose luggage rack	46
Before the first ride	4	Installing the pedals	21	Bar ends/handlebars	46
Before each ride	5	Adjusting the saddle	22	Mounted accessories	47
Riding a pedelec	6	Adjusting the saddle tilt	23	Accessories / maintenance / spare parts	47
How your pedelec works	6	Handlebar position/adjusting the stem	23	How to use carbon components	50
Your pedelec's range	6	Setting up the brake levers	24	Properties of carbon	50
If you have a fall	7	Children	25	Transporting the Bike	51
Legal regulations	8	Children and pedelecs	25	Replacing parts	52
Separate regulations for		Carrying children/trailers for children	25	Warranty and liability in the case of defects	55
S-pedelecs/e-bikes	8	Frame	27	Environmental protection tips	56
Intended use	9	Suspension	28	Legal disclosure	56
Pedelec tuning is prohibited	11	Suspension frames and suspension elements	28	Inspections	57
Electrical system	12	Maintenance and upkeep	29	Hand-over documentation	60
Important safety instructions for electrical and electronic systems	12	Chain	30	Pedelec identification	61
Switching the electrical system on and off	13	Belt drive	31	Notes/guarantee	62
Display and control unit	13	Wheels	32		
Battery	14	Wheels/Tires	32		
Charging the battery	16	Tires and tire pressure	33		
Charger	17	Flat tire repair for conventional tires	34		
		Brakes	36		
		Gear change	40		

Safety instructions

Please read all warnings and advice in this instruction manual carefully before using your pedelec.

Please keep the instruction manual in a safe place for later use. Keep it close to your pedelec so that you can access it at any time

The manufacturer accepts no liability for damages resulting from non-compliance with these instructions. Your pedelec must only be used in accordance with its intended use.

Any other use may lead to technical failures and accidents. Liability for defects and warranty will be void in case of improper use.

Please ensure you read the chapters “Before the first ride” and “Before every ride” before using the pedelec for the first time!

If you lend your pedelec to a third party, please give them this operating manual along with the pedelec.

This operating manual contains five different types of pointers – one providing important information about your new pedelec and how to use it, a second referring to possible damage to property and the environment, and a third type warning against potential falls and serious damage, including physical injury. The fourth pointer helps you to apply the proper torque so the parts don't loosen or break. The fifth pointer reminds you that it is necessary to study the operation and assembly manuals included carefully.

When you see these symbols, there is always a risk that the described danger may occur.

The text which the warning covers always has a grey background.

The warnings break down as follows:



Information: This symbol provides information about how to use the product or highlights specific parts of the operating manual that are particularly important.



Warning: This symbol warns of misuse which could result in damaging the product or the environment.



Danger: This symbol indicates possible dangers to your health and life that could arise if specific actions or appropriate care is not taken.



Important screw joint: Precise torque must be applied here when tightening. The correct mounting torque is either displayed on the component or listed in the table of torques on page 45. In order to apply a precise torque, you must use a torque wrench. If you don't have a torque wrench, please contact a specialist dealer. Parts which do not have the correct torque could fall off or break! This may result in severe falls.



Operating Instructions: Read all of the instruction manuals delivered with the pedelec. If you are unsure about any of the topics addressed in this handbook, contact your specialist dealer.

Introduction

Dear Customer,

to start with, we'd like to provide you with some important information about your new pedelec. This will enable you to handle the technology better and to avoid risks. Please read the operation instructions carefully and keep them in a safe place for later reference.

The pedelec you have received has been assembled and adjusted according to your body type. If this isn't the case, please contact a bike shop to have this necessary work done on your bike, or make sure that you carefully read the manufacturer's assembly instructions and follow all of the steps included within.

It is assumed that the pedelec's user has acquired the basic necessary knowledge to operate pedelecs.

Everyone that

- uses
- repairs or services
- cleans
- or disposes of this pedelec

must completely acknowledge and understand the content and meaning of these operation instructions. If you have any further questions or have not quite understood certain points, you should contact a specialist pedelec retailer for your own safety.

This manual contains information about construction, technology, maintenance and servicing. Please take note of this information, as

much of it is relevant to safety. Failure to consider this information can cause serious accidents and damage to property.

As modern pedelec technology is highly complex, we have chosen to only describe the most important points.

As well as this, this manual only applies to the pedelec for which it was issued

The technical details concerning the parts installed to the bike can be read in the attached instructions and reference materials provided by each of the bike's manufacturers. If you are unsure about a particular point, please contact your specialist retailer.

Before riding your pedelec on public roads, you should inform yourself about the applicable national regulations in your specific country.

First, however, a few pointers which the person using the pedelec should consider before starting a journey:

- Always wear a fitted and suitable bicycle helmet and use it each time you ride.
- Read the instructions supplied by your helmet manufacturer relating to fitting the helmet properly.
- Always wear bright clothing or sportswear with reflective elements when you ride. If you are riding in difficult terrain, please wear suitable clothing, such as protective bike wear.
- Tight clothes and trouser clips are mandatory to wear. Your shoes should be slip-resistant and have hard soles.



Even if you are an experienced pedelec user, it is essential that you first read the chapter "Before your first ride" and then carry out all the important checks from the chapter "Before every ride".

Please note that as a pedelec rider, you are particularly at risk on public roads.

Ensure that you protect yourself and others with responsible and safe riding.

Note for parents and legal guardians:

As your child's legal guardian, you are responsible for their actions and safety. This includes taking care of the pedelec's technical condition and supervising the rider.

In addition, you should also ensure that your child has learnt how to use the pedelec safely. They should know how to ride the pedelec properly and responsibly in the environment in which it will be used.

- Please note that in some countries, children may only cycle on pavements or footpaths until they have reached 8 years of age. Children between 8 and 10 may also use pavements or footpaths.
- When children cross a road, they must get off their bike.

For your safety

This operating manual assumes that you have a basic knowledge of riding pedelecs/bicycles. It will not teach you how to ride a pedelec/bicycle. Likewise, it does not explain how to assemble or repair the pedelec.

Always be aware that pedelecs may give rise to risks, especially to riders themselves. Always be aware that you are not as protected as you are in a car, for example. Pedelecs have no airbag and no body. Nevertheless, you are faster and can ride on other areas of the road compared to a pedestrian. Pay particular attention to others on the road. Never ride with headphones. Never use your phone while riding. Never cycle if you are unable to control your bike completely. Under no circumstances should you ride your bike if you have taken medicine or are under the influence of alcohol or drugs.

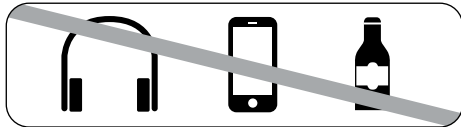

- Under wet and slippery conditions, adapt how you cycle accordingly. In this case, you should ride more slowly and brake earlier and more gradually, as the braking distance becomes significantly longer.
- Ride at an appropriate speed for the terrain and your riding capabilities.



Before the first ride



Please consult the operating manuals of the individual component manufacturers, which were supplied with your pedelec or can be found online.

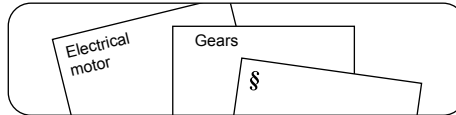

Your specialist pedelec retailer will be happy to answer any further questions you have after reading this manual.

Ensure that the pedelec is ready for use and adjusted to fit your body.

This means:

- Checking the position and attachment of the saddle and handlebar
- Mounting and adjusting the brakes
- Making sure the brake handles are easily accessible (see page 24)
- Fastening the wheels securely onto the frame and the fork
- Checking the battery is firmly fastened
- Ensuring the battery is sufficiently charged for the planned trip
- Familiarising yourself with how the pedelec should be used

To ensure that you enjoy a safe and comfortable riding position, please allow your specialist retailer to set up your handlebars and stem. Adjust the saddle to find a safe and comfortable position for you (see page 22).

Allow your specialist retailer to set up the brakes so that the brake levers are always within easy reach.

Ensure that you know which lever operates which brake (i.e. left or right, and front or back).

Usually, the right brake lever operates the rear wheel brake and the left brake lever operates the front wheel brake.

Despite this general rule, however, you should still check which wheels the brakes are connected to since this standard isn't always followed.



Modern braking systems might be more powerful or have a different functionality than those that you are used to. Practice operating the brakes in a safe area without traffic before you start a journey.

If you use a pedelec with carbon fibre wheels, please note that this material provides a significantly weaker braking effect in combination with rim brakes than aluminium rims do!

Also remember that the effectiveness of brakes can be different to what you are used to in wet conditions or on slippery surfaces. Adapt the way you cycle for slippery surfaces with possibly longer braking distances.



If rubber or plastic pedals have been put on your pedelec, familiarise yourself with their grip. When wet, rubber and plastic pedals are very slippery.

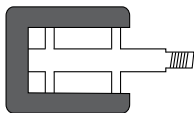

Snagging hazard

Moving and turning parts of your pedelec may lead to danger during use, maintenance and upkeep. Protect yourself by not wearing loose clothes that may get caught. During use, maintenance and upkeep, stay away from turning parts (wheels, brake discs, cassettes). Do not touch moving, sharp or protruding parts (cranks, pedals).

Make sure the wheels are securely fastened in the frame and fork. Check that the quick releases, slide-in shafts and all important nuts and bolts are secure (see page 20 and 45).

Lift your pedelec up slightly and drop it onto the ground from about 10 cm in the air. If it rattles or makes another unusual noise, ask a specialist retailer to identify and fix the problem before you use it.

Try to roll the pedelec forwards while pressing the brakes. The rear brake, when operated, must allow the rear wheel to lock, the front brake must lift the rear wheel off the ground. Please make an initial test ride in a safe place where you can familiarise yourself with the new brakes! Modern brakes can behave completely differently than those that you are perhaps used to. The pedelec's steering should not rattle or have any play.

Check the air pressure in the tires. You will find information as to the correct tire pressure on the sides of the tires. Please adhere to the required minimum and maximum pressure!

If you cannot find the recommended pressure values, 2.5 bar / 36 PSI is a suitable pressure for most tires. If the tire is narrower than 30 mm or 1 1/8", fill it to 4 bar / 58 PSI.

As a general rule of thumb when you are out on a ride, you can check the tire pressure by doing the following: If you place your thumb on a pumped-up tire, you should not be able to significantly change its shape by applying pressure.

In addition, check whether there is an indication of maximum tire pressure stated on the rim. If so, this specified pressure must not be exceeded.

Check the tires and rims. Look for damage, cracks and deformations, foreign objects, eg glass splinters or sharp-edged stones, etc.

Never ride your pedelec if you notice cuts, tears or holes. First have your pedelec checked over by a specialist.

Before each ride

Before every ride, please check that:

- The lights and bell are working and safely secured
- The brakes are working and are safely secured
- The cables and fittings are not leaking if you have a model with hydraulic brakes
- The tires and rims are free of foreign objects and bear no damage and turn smoothly, particularly after riding off-road
- The tires have a sufficient tread depth
- The spring elements are working and safely secured
- The screws, nuts, quick release axles and quick releases are tight (see page 20) even if the pedelec has been left unattended for a short time
- There are no deformations or damage on the frame and fork.
- The handlebars, stem, seat post and seat are correctly and securely fastened and set up in the right position.
- The seat post and seat are secure. Try turning the seat or tipping it upwards or downwards. The seat should not move.
- If you are using clipless or magnet pedals, please check that they are working properly. The pedals should release easily and smoothly.
- The battery is secure
- Ensure the battery is sufficiently charged for the planned trip



Do not use your pedelec if you think it may not be in perfect condition. Have a specialist retailer check your bike. It is particularly important if you use your pedelec a lot, either for sports or daily use, that you regularly have all the important parts checked by a specialist retailer. Frame and fork, suspension components and other parts relevant to your safety such as brakes and wheels are subject to heavy wear, which can impact the operating safety of these parts. A component may unexpectedly begin to malfunction if you use it beyond its lifespan or recommended period of use. This may lead to accidents and serious injury.



Please make these checks before continuing after an accident or if your pedelec falls over. Aluminium parts cannot be safely bent back into shape, while carbon components can sustain damage which is not recognizable to the eye. Do not use your pedelec if you think it may not be in perfect condition. Have it checked and repaired by a specialist retailer. If damaged, aluminium parts are non-repairable. Carbon components can sustain damage which is not visible to the eye!

Riding a pedelec



Practice operating and riding your pedelec in a quiet and safe place before you take to public roads!



Please read all warnings and advice in this instruction manual carefully before using your pedelec.



Always squeeze the brakes of your pedelec before placing a foot on the pedal. The electric engine starts working as soon as you begin to pedal. This boost is surprising to begin with, and can lead to falls or cause dangerous traffic accidents and injury to occur.

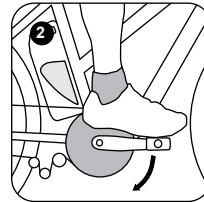
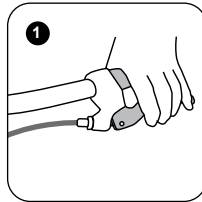

- Staring at the display screen for too long while cycling may result in you falling off or causing an accident.

- When riding a pedelec, make sure that you are fully familiar with the starting characteristics of the pedelec before riding it. If the pedelec starts off suddenly, accidents may occur.
- Neither the bike nor the drive may be tampered with to increase the speed or performance of the pedelec. The application of tuning kits or modifying the gear transmission is not permitted.

How your pedelec works

The drive is activated as soon as you begin to pedal. The amount of assistance depends on the settings you have chosen. The drive unit turns off as soon as you stop pedalling or reach maximum speed (25 km/h). The assistance is automatically reactivated as soon as the speed is below the maximum assistance speed and you reapply pressure to the pedal.

How to most efficiently use your pedelec engine:

- Always select the optimal gear and keep your pedalling rate between 60-100 rpm.
- Start with the low gears.
- As soon as your pedalling rate becomes too high, shift to the next higher gear.
- As soon as your pedalling rate becomes too low, shift to the next lower gear.
- If your pedelec uses a hub gear, reduce your pressure on the pedal before shifting gears.

Your pedelec's range



It is best to charge your battery at warm temperatures and set it just before you start a journey.

The battery's drain cycle may be effected by:

- Assistance level:
The higher the assistance level used, the higher the power consumption and the lower the range.
- Riding style:
With the optimal use of gear shifting, you can save energy. In lower gears, you generally need less power, less assistance, and your pedelec consumes less energy.
- Ambient temperature:
Batteries discharge faster at cold outside temperatures and have a shorter range.
- Terrain:
In hilly terrain, more energy is needed so the range goes down.
- Weather and vehicle weight:
In addition to the temperature, wind conditions can also have an effect on the range. A strong headwind requires more power when cycling. Bags and luggage will increase the weight, therefore more force is required.
- Technical condition of your pedelec:
Air pressure that is too low in the tires increases driving resistance, especially when riding over a smooth surface, such as tarmac. The range of your pedelec can be reduced by a rubbing brake or a poorly maintained chain.
- Charging status of the battery:
The charge state indicates the amount of electrical energy that is stored in the battery at any given time. More energy means more range.

If you have a fall

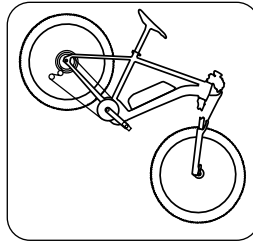

Check the entire pedelec for any damage. This could be dents and cracks in the frame and fork but also bent parts. Also, if any parts such as the handlebars or seat have shifted

or twisted, you need to check that these parts are working and safely secured.

- Examine the frame and fork closely. If you examine the surface from different angles, you usually will be able to clearly see any deformations.
- Check that the seat, seat post, stem and handlebars are still in the correct position. If this is not the case, DO NOT attempt to turn or bend the part back from its new position without undoing the corresponding screws. When fastening parts, always use the specified tightening torque. These values can be found on page 45 and in the chapter "Quick Release" on page 20.
- Check that both wheels fit correctly and securely in the frame and fork. Lift the pedelec up at both the front and rear to turn the front and rear wheels. The rim should move smoothly straight through the brakes. The tires must not touch the brakes. You can see from the distance between the frame or fork and the wheel whether the wheel turns without rubbing.

- Check that both brakes are operating fully.
- Do not set off again without having checked that the chain is fixed securely onto both the front chain wheel and rear sprockets. It must be engaged fully with the cogs. If you set off and the chain slips off a cog you may fall, at the risk of injury.



Aluminium components can break unexpectedly when deformed. Do not use any parts that have been deformed or bent, such as after a fall. Always replace these parts. Carbon parts can be seriously damaged without it being noticeable. After a fall, have all carbon components checked by a specialist retailer.

If you notice any changes to your pedelec, DO NOT continue cycling. Do not retighten loose parts without prior inspection and not without a torque key. Take the pedelec to a specialist retailer. Tell them about the fall and have the pedelec examined!

Legal regulations

Within the scope of the European Union, there are different types of pedelecs and e-bikes for which different legal regulations apply.



A pedelec (pedal electric cycle) is a bicycle in which the rider is assisted by an electric drive when pedalling. Its engine can go up to 250 Watts (UK: 200 W), and its maximum speed limit is 25 km/h. It is therefore still considered to be a bicycle which does not need to be registered. The S-pedelec is the faster model. Once again assistance is only provided when pedalling, but it has a more powerful engine. It is generally 350 to 500 Watts and has a cut-off speed of 45 km/h. It is therefore regarded as a moped, light motorcycle or motorbike depending on location and is required by law to be registered and insured in Germany.



Find out about the relevant national stipulations that apply to you! Check your cycle passport to see which type of pedelec you have. Respect the legal regulations. Also, ask your specialist retailer.



Check whether your third party liability insurance covers possible damage caused by using an pedelec.

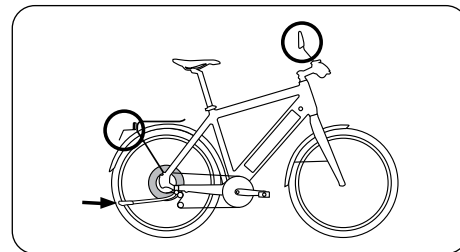
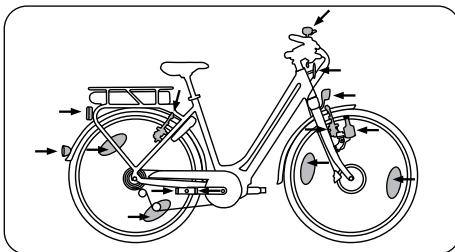

 According to EU law, a pedelec is under the same category as a bicycle and, therefore, has the same requirements. The rules for using pedelec paths are also the same as for bicycles. Special rules may apply outside the EU and in some EU regions. Please stay informed about the national regulations applicable in your specific country.

To use bike paths with your pedelec, please consult the applicable legal practice in your country. The regulations governing the operation of a pedelec and the requirements regarding minimum age, certificates, official licenses and helmet requirements may vary in different countries. The same applies to the obligatory use of cycle paths. Please inform yourself about the applicable legal practice.

Separate regulations for S-pedelecs/e-bikes

If pedal assistance is provided above 25 km/h, it is not considered a pedelec/e-bike according to Directive 2002/24/EC which has since expired. According to the current EU Regulation 2013/168/EU, type approval/approval for specific use is mandatory.

According to EU law:

- Speed pedelecs (S-Pedelec) are legally categorised as two-wheeled motor vehicles in class L1e, subcategory L1e-B (mopeds).
- On journeys using engine assistance only, you are not permitted to ride over 18 km/h.
- The engine assistance switches off when you reach approx. 45 km/h.
- A driving licence is required. The moped test certificate is mandatory.
- A driving license is required. Please inform yourself about the applicable regulations regarding licenses. It is possible that a minimum age is enough to be allowed to ride without a driving license.
- If you have a national driving license for a car, the required permission may be covered by this.
- You are required by law to wear a helmet and be insured. Before setting out on a ride, find out about the legal stipulations that apply to you.

- In general, parts can only be replaced by identical parts. Other parts may only be installed if they comply with your speed pedelec's type approval. Specialist retailers may have lists of alternative parts which also comply with your speed pedelec's type approval.
- **Child seats** may only be installed on speed pedelecs if they have been approved by the speed pedelec manufacturer.
- **Passenger trailers** are not permitted for speed pedelecs, not even with approval from the speed pedelec or trailer manufacturer.
- **The blood-alcohol level limit is the same as when driving a car depending on the applicable legal stipulations.**

These regulations also apply to you if you are within the scope of the European Union. Other regulations may apply in other countries, including some European nations in isolated cases. Please inform yourself about the applicable legislation for using your speed pedelec.

Speed pedelecs/e-bikes and bike paths

If you use your speed pedelec like you would a normal bicycle, without the assistance of the electric motor, you are permitted to use all cycle paths without limitation. The following applies if you use the motor: Like for mopeds, you have to use cycle paths outside of urban areas when riding a speed pedelec. If this is not permitted, this is displayed by an additional sign on the cycle path stating "no mopeds". In urban areas, you are only permitted to use cycle paths which feature an additional sign permitting you to do so.

Intended use



Pedelecs are means of transport designed to be ridden by one person. Transporting an additional person on the bike is only permitted in the framework of national legislation. A tandem is exempt from this.

If you would like to transport baggage, your pedelec needs to be fitted with suitable equipment. Children may be transported in child seats or in trailers intended for this purpose. Pay attention to quality. Ensure that you do not exceed the maximum permissible weight.



Permissible total weight: weight of the rider + weight of the pedelec + weight of the battery + weight of the baggage + weight of the trailer (if the trailer is permitted) (see page D).



Dangers of improper use
Only use your pedelec for its intended use. Please read the section "Intended Use" in the original instruction manual. This also includes adherence to the operating, servicing and maintenance conditions that are described in this manual. Inform other users of the intended use and the dangers of not adhering to it. Improper use, overloading and lack of maintenance may lead to accidents and falls involving severe injuries to you and other people!



The electrical components are exclusively for use in electrically assisted bicycles, i.e. pedelecs or EPACs. They are not to be used for any other purpose. It is not permissible to use it for competitions or commercial purposes.



Keep in mind that on a pedelec you are travelling much faster than you would on a bicycle without an electric drive. Other road users may misjudge this. If anything is unclear about the intended purpose of your pedelec, please contact your specialist dealer.

If they are equipped as prescribed by national law,

Type 1

Trekking pedelecs

may be used on public roads and on light terrain, such as on dirt roads.

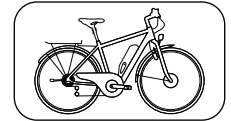

Instructions for use

Manufacturers and retailers are not liable for any use outside of the intended use. This applies particularly to damage resulting from failure to comply with the safety instructions, for example:

- use on terrain,
- use for purposes outside of its intended use,
- overloading, or
- the improper repair of defects.

Trekking pedelecs are not designed for heavy strain, such as riding down stairs or going over jumps, or for extreme uses, such as authorised competitive events, tricks or stunts. Participation in competitions is only allowed when authorised by the manufacturer.

Type 2

City and touring pedelecs

may be used on public roads and on paved roads.

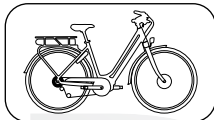

Instructions for use

Manufacturers and retailers are not liable for any use outside of the intended use. This applies particularly to damage resulting from failure to comply with the safety instructions, for example:

- use on terrain,
- use for purposes outside of its intended use,
- overloading, or
- the improper repair of defects.

City and touring pedelecs are not designed for heavy strain, such as riding down stairs or going over jumps, or for extreme uses, such as authorised competitive events, tricks or stunts. Participation in competitions is only allowed when authorised by the manufacturer.

Type 3

Mountain pedelecs

may be used on public roads and on light to intermediate terrain such as dirt roads, trails and cross-country courses thanks to their suspension travel of up to 120 cm.

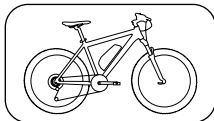

You can ride over small obstacles like roots, stones or steps. You should always wear the appropriate safety equipment (eg. a suitable helmet and cycling gloves).

Instructions for use

Manufacturers and retailers are not liable for any use outside of the intended use. This applies particularly to damage resulting from failure to comply with the safety instructions, for example:

- using the bike on difficult terrain, jumps, steep descents or in bike parks
- use for purposes outside of its intended use,
- overloading, or
- the improper repair of defects

Mountain pedelecs are not designed for heavy strain, such as riding down stairs or going over jumps, or for extreme uses, such as authorised competitive events, tricks or stunts.

Type 4

Mountain pedelecs – Suspension travel approx. 120-150mm

may be used on public roads and on light to intermediate terrain. Obstacles like roots, stones or low steps may be ridden over. Small jumps are permitted. You should always wear appropriate protective gear (i.e. helmet, biking gloves, protectors).

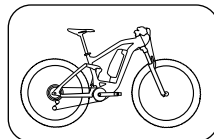

Instructions for use

Manufacturers and retailers are not liable for any use outside of the intended use. This applies in particular to

non-compliance with the safety instructions and any damage resulting from this, such as:

- using the bike on difficult terrain, for high jumps, downhill or in bike parks
- use for purposes outside of its intended use,
- overloading, or
- the improper repair of defects

All mountain pedelecs are not designed for heavy strain, such as steep descents or going over high jumps, or for extreme uses, such as authorised competitive events, tricks or stunts.

Type 5

Enduro pedelecs – Suspension travel around 150-180mm

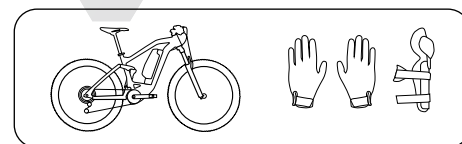

may be used on public roads and on terrain. Obstacles like roots, stones or low steps may be ridden over. Jumps are permitted. You should always wear appropriate protective gear (i.e. helmet, biking gloves, protectors).

Instructions for use

Manufacturers and retailers are not liable for any use outside of the intended use. This applies particularly to damage resulting from failure to comply with the safety instructions, for example:

- using the bike on difficult terrain, for high jumps, extreme downhill use or energetic bike park use
- use for purposes outside of its intended use,
- overloading, or
- the improper repair of defects

Enduro pedelecs are not designed for heavy strain, such as steep descents or going over very high jumps, or for extreme uses, such as authorised competitive events, tricks or stunts.

Type 6

Freeride/Downhill pedelecs

Suspension travel starting at 180 mm

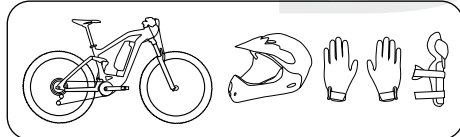

may be used on public roads and on rough terrain. Obstacles like roots, stones or low steps may be ridden over. High jumps are permitted. You should always wear the appropriate safety equipment (e. g. helmet with visor, cycling gloves, protectors).

Instructions for use

Manufacturers and retailers are not liable for any use outside of the intended use. This applies particularly to damage resulting from failure to comply with the safety instructions, for example:

- using the bike on very difficult terrain, for very high jumps, extreme downhill or energetic bike park use
- use for purposes outside of its intended use,
- overloading, or
- the improper repair of defects

Freeride/Downhill pedelecs are not designed for heavy strain, such as extreme uses like authorised competitive events, tricks or stunts.



If you are not sure what type of pedelec you have, ask your specialist retailer or the manufacturer about its intended uses. Before riding on public roads with your pedelec, inform yourself about the applicable regulations in your country. Only ride on pathways and trails that are permitted for vehicles. Special regulations may apply in part. Please inform yourself about the applicable national regulations in your specific country.

Pedelec tuning is prohibited



Unauthorised intervention is prohibited

Do not modify the pedelec's technology in any way. Manipulating the bike in any way to increase performance or speed can lead to legal problems and/or make the bike less safe to ride. Sprockets may not be replaced by parts that are not original parts.

Possible legal implications:

- The pedelec is required by law to be registered for approval and insured. All legal requirements regarding the bike's configuration and as stated by the road traffic licensing authority must be adhered to.
- The manufacturer does not offer any kind of guarantee, warranty or liability.
- Criminal consequences cannot be ruled out. For instance, an accident with a tuned pedelec may result in a legal offence.
- Termination of pedelec/bicycle insurance

Possible technological implications:

- Tampering with the bike's technology may limit its capabilities, cause defects or break the bike parts.
- The motor and battery may become overloaded and overheat. Consequences: Irreparable damages and risk of fire
- The brakes and other parts may become overworked. Consequences: Malfunction, overheating, increased wear and tear

Electrical system



Modern pedelec technology is high tech, and working on pedelec parts requires expert knowledge, experience and specialist tools. Do not do any work on your pedelec yourself. Contact a specialist dealer.

The electrical system includes the following components:

- Display
- Control unit
- Battery
- Drive unit
- Charger
- Sensors

The A-weighted emission sound pressure levels at the rider's ears is below 70 dB(A).

Important safety instructions for electrical and electronic systems



The electrical system of your pedelec is very powerful. If you notice any damage to the electrical system, remove the battery immediately. After a fall or accident, live components may be exposed. If you have a question or problem, please contact a specialist dealer. A lack of expertise can lead to serious accidents.



Before performing any work on your pedelec, disconnect the electrical system and remove the battery.



Do not clean the pedelec with a steam jet, high-pressure cleaner or water hose. Water may seep into the electrics or drive and destroy the equipment.



The operating temperature should be between -15°C and $+45^{\circ}\text{C}$. The recommended storage temperature is between -10°C and $+35^{\circ}\text{C}$.



Only perform operations described in this manual. Do not change the bike. You should not disassemble or open any modules. If in doubt, always contact a specialist dealer.

Replace parts that are defective or worn, such as the battery, charger or cable, with original spare parts produced by the manufacturer or parts recommended by the manufacturer. Otherwise, any guarantees and/or manufacturer's warranties will be voided. If non-original or incorrect spare parts are used, the pedelec may not function correctly. In case of a defect, please contact a specialist dealer.

Improper operation of the drive system and changes made to the battery, charger or motor may result in injury or costly damage. In this case, the manufacturer declines any liability for the damage caused. Changes to the electric system may result in criminal prosecution. This may be the case if the maximum assisted speed is modified.



Your pedelec is supplied with the corresponding operating manual for the integrated drive from the component manufacturer. For more information about the bike's operation, maintenance, upkeep and technical data, read the instruction manual along with the websites for each of the manufacturer's parts.



Don't let children who are unattended ride the pedelec without first thoroughly instructing them on how to use it. Explain to children the dangers of using electrical devices. Do not allow children to play near the product.



The pedelec is not intended for use by persons (including children) with reduced physical, sensory or mental capabilities, or lacking the required experience and knowledge, unless supervised or having received instructions concerning use of the product by a person responsible for their safety.



This pedelec can be operated in the rain. However, do not deliberately immerse it in water.



When shipping the pedelec on a vehicle exposed to rain, remove the battery and store it in a safe place to stop it from getting wet.

Your pedelec has a “pushing aid” function, whereby it moves at up to 6 km/h without the need to pedal yourself.



The pushing aid function works to assist you if you, for example, have to climb a steep ramp from an underground car park or underpass. Do not use it to ride the bike.



Both wheels must be on the ground when using the pushing aid, otherwise there is a danger of serious injury.

Switching the electrical system on and off

To switch the electrical system on, use the on/off key on the external control unit (if there is one) or the on/off key on the battery. To turn it off, push and hold down the same key until the system turns off.

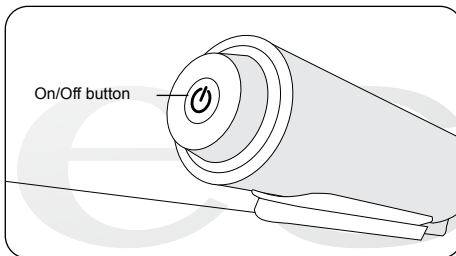
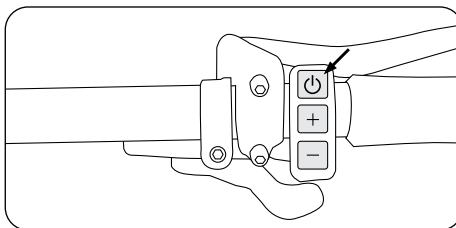

Requirements:

The following requirements must be met before you can activate and use your pedelec:

- A sufficiently charged battery must be used.
- The battery must be inserted correctly into the battery holder.
- The motor, control unit, battery, etc. must all be connected correctly.

Display and control unit



Your pedelec can be equipped with various displays and control units. Some manufacturers offer the possibility to link the display with your smart-phone and configure the settings.

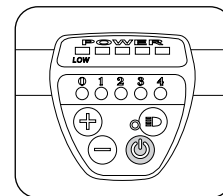
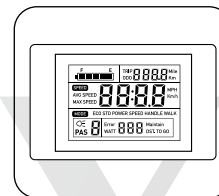

Please refer to the enclosed functional description and operating manual provided by the manufacturer.

Battery



Your pedelec can be equipped with different batteries. The battery can be mounted onto the luggage rack or the frame. In some models the battery is integrated into the frame. More specific details and specifications can be found in the manufacturer's instruction manual delivered with your pedelec.



When inserting the battery, always make sure that it is fully snapped into place and locked in the holder. Without contact with the battery, the electric drive of your pedelec will not work.

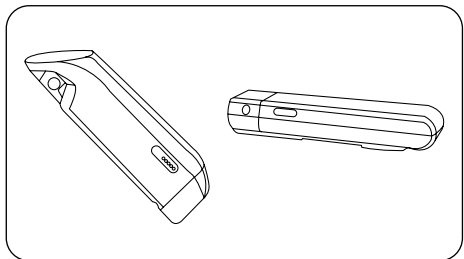

Read the indications printed on the external label of the battery before using the battery.

Rechargeable Li-Ion Battery

Model No: SF- D6S
Nominal Voltage: 48V DC
Energy: 556.8 Wh
Capacity: 11.6 Ah
Cell designation: 13ICR19/66-4

Safety advices for Lithium-Ion batteries

Don't crush Don't heat or incinerate Don't short-circuit Don't dismantle Don't immerse in any liquid it may vent or rupture

Respect charging instructions

Charge 0 to 50 °C Discharge -10 to +60 °C
Made in Germany
GEB 15-V5/Art.: 14091-3/F119205



Label (example)



Use only original chargers from the manufacturer to charge the battery.

- The battery is not fully charged when delivered. Recharge the battery completely before the first use and before storing.
- Under normal operating conditions, immediately charging the battery after each use will increase the battery's lifespan. Never allow your battery to drain completely. Recharge your battery even after using it for a short time.

- Do not charge the battery for longer than recommended by the manufacturer.
- If the battery is completely discharged, charge it as soon as possible. Leaving the battery uncharged for long periods of time will damage its capacity.

When using or giving out a spare key for the battery, be sure to provide the number on the battery key. Please keep the number in your mind or your notebook.

Safety Instructions



Risk of fire or explosion if battery is used with an incompatible system. Do not open, disassemble or pierce battery due to risk of short circuit, fire or explosion. Should the battery fall or suffer a heavy impact, stop using it and consult a specialist retailer. Only use the original charger as supplied with battery due to risk of fire or explosion. Disposal of used batteries should follow locally enforced regulations. Please carefully read the manual before use.

- Use the charger only in dry areas and do not cover it during operation. It could otherwise short circuit or cause a fire.
- When cleaning the charger, always unplug the charger from the power outlet first.
- Read the instructions on the charger before you start charging the battery.

- Do not drop or throw the battery. Avoid any strong impacts. This may result in fluid leakage, fire or explosion.
- Do not apply force to the battery. If the battery becomes deformed, the built-in safety mechanism may be damaged. This may result in fire or explosion.
- Do not use the battery when damaged. The battery fluid may leak, and it can cause loss of vision if it comes into contact with your eyes!
- Remove the battery from the pedelec if you want to transport it (e.g. by car).
- Also, remove the battery if you want to do any work on the pedelec (e.g. maintenance, assembly). You are at risk of injury or electric shock if you accidentally press the on/off switch.
- Never open the battery. Doing so may cause a short circuit. Any warranties or guarantees are void if the battery has been opened.
- Do not store or carry the battery with metal objects that can cause short circuits (e.g. paper clips, nails, screws, keys, coins). A short circuit may result in burns or fire.
- Keep the battery away from heat sources, such as strong sunlight and fire. Failure to do so may result in an explosion.
- Do not expose the battery to water or other liquids. Contact with them may damage the battery's safety circuit and safety mechanism. This may result in fire or explosion.
- Do not clean the battery with a high-pressure washer. Use a damp rag when cleaning the battery. Never use aggressive cleaning solutions.
- If improperly used, the battery may leak fluid. This may result in skin irritation and burns. Avoid contact with the battery fluid. If you do come into contact with it, rinse the fluid off with plenty of water. In case of contact with eyes, seek medical attention.
- Fumes may be released in the event of damage and/or improper use. Provide fresh air and seek medical attention in the event of any complaints.
- The battery must be fully snapped into place and locked in the holder before beginning a journey, you may otherwise lose the battery while riding.
- Avoid deep discharging the battery. Doing so will result in irreversible cell damage.
- The battery is only suitable for use with electric bicycle drives from pedelecs. Improper use or handling may result in injury or fire. The manufacturer is not liable for any damage resulting from improper use.
- Do not expose the battery to temperatures outside the permissible storage temperature range of -10°C to 35°C. Note that temperatures of over 45°C are common near heaters, in direct sunlight or in overheated vehicle interiors.
- When storing the battery for a longer period, make sure it is charged to at least half its capacity, and charge it again three months later. Do not wrap it with conductive material, as to do so will cause damage due to direct contact between metal and the battery.



If you notice the battery becoming hot during use, charging or storage, developing a strong odour, changing appearance, or any other abnormality, do not continue to use the battery. Contact a specialist dealer.

Battery storage



If you do not use your Pedelec for an extended period of time, remove the battery, charge it (60-80%) and store it separately in a frost-free, dry room.

- Avoid direct sunlight. This can lead to overheating, distortion, rupturing, poorer performance and a shorter lifespan of the battery.
- To prevent deep discharge, the battery will go into sleep mode after a certain time.

Battery wear



The battery can be charged approximately 500 times. The battery capacity decreases during this time, making the battery drain faster with the use of the pedelec's motor assistance. This does not constitute a defect. Technically, this counts as battery use. If the range is still sufficient, you can continue to use it

The battery life depends on various factors:

- The number of charging operations (about 500 charging cycles)
- The age of the battery
- Storing and Operating Conditions

Of course, your battery will deteriorate and capacity will be lost even if you do not use the battery.

The lifetime of your battery can be lengthened by the following measures:

- Charging your battery after every ride, even short trips. Lithium-ion batteries are not subject to a memory effect.
- Avoiding using high gears with high assistance levels.

Charging the battery



You can usually charge your battery both while it is mounted on the pedelec and removed. Please read the component manufacturer's operating instructions in this regard.



Lithium-ion batteries are not subject to a memory effect. You can recharge your battery at any time, even after short trips.

Charge your battery at temperatures between 0°C and 45°C (ideally at room temperature or 20°C). Do not charge the battery if it is still warm or hot after intensive use. Give the battery sufficient time before charging to reach this temperature.



Before charging, read the drive manufacturer's instructions in the system manual and on the charger.

Typical charging process

1. First insert the plug of the charging cable into the charging socket on the battery, then the plug the charger into a socket.
2. As soon as the charger is connected to the power supply, a red LED will light up.

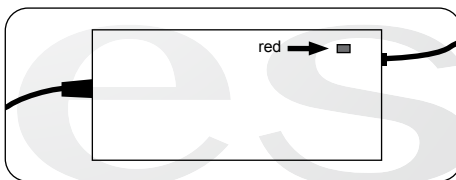

3. When charging is complete, the LED changes from red to green. As soon as the battery is fully charged, first remove the plug from the power outlet and wait until the LED on the charger goes out. Only then should you remove the plug from the battery.

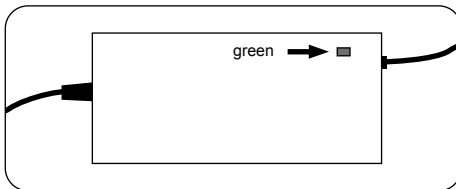

Charging time depends on various factors. It can vary greatly according to the temperature, age, usage and capacity of the battery. Information about your battery's charging time can be found in the technical information regarding your battery.

When the battery is fully charged, the charging process is automatically terminated. Unplug the plug from the battery and the power outlet.

Safety instructions



Only use the charger designed for your battery.

Make sure you use the correct mains voltage. The required mains voltage is indicated on the charger. It must comply with the voltage of the current source. Chargers marked 230V can also be operated at 220V.

- Do not touch the power plug with wet hands. There is a risk of electric shock.
- Note: Sudden temperature changes can cause condensation to form on the battery. Avoid this by storing the battery in the same place it is charged.
- Before use, check that the charger, cable and plug are not damaged. If damage occurs, do not use the charger. There is a risk of electric shock.
- Charge the battery in well-ventilated rooms only.
- Do not cover the charger and/or battery during charging. There is a risk of over-heating, fire, or explosion.
- Only charge on a dry, non-flammable surface.



The battery has to be recharged completely at least every 3 months, in order to avoid damaging or destroying the cells.



If the charging cycle is taking longer than usual, the battery may be damaged. In this case, immediately stop charging. Contact a specialist dealer.

Error description	Cause	Solution
The LED does not light up.	The mains plug is not properly connected to the power supply.	Check all connections and whether the charger is properly plugged into the power supply.
The LED does not light up even after checking the power supply.	The battery may have a malfunction.	Contact a specialist dealer.

Charger



The charger is specially designed for charging lithium-ion batteries. It is equipped with an integrated fuse and protection against overcharging.

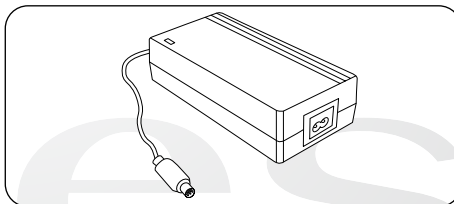

Operating instructions



Read the indications on your charger's external label before using the battery.

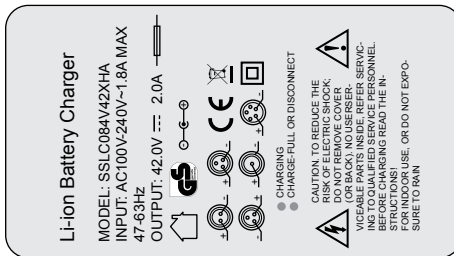

Label (example)



The charger must not be taken apart. Leave maintenance work to qualified professionals and consult a specialist retailer. Make sure to read the information about your battery charger before charging your battery for the first time. Unplug the charger before attaching or removing the battery from the charger. Flammable gases can leak out. Prevent flames and sparks.



Keep the charger away from children and animals. Small children and animals may damage the cable while playing. This can lead to an electric shock, a malfunction or a fire.

- The charger must not be used by children, or by persons with limited physical, sensory or mental capabilities, unless under the supervision of a responsible adult.
- Make sure the charger is clean to avoid risk of electric shock.
- Do not use your charger in humid or dusty places.
- Avoid direct sunlight.
- Only use the charger that came with your pedelec or one produced by the same manufacturer.
- Don't cover the charger while it is in use. It could otherwise short circuit or cause a fire.
- When you clean the charger, unplug it from the electrical socket first.

- If the charging process takes longer than recommended by the manufacturer, stop it before the end.
- After charging, if not in use, remove the battery from the charger and unplug the charger.

Drive unit



Your pedelec can be powered by a front engine, a mid-engine or a rear engine.



Keep in mind that the motor of your pedelec can heat up during long uphill runs. Do not touch the motor, as you may get burnt.



In hub motors, you hear a quiet driving noise during operation. This noise may grow louder with increased strain and is completely normal.



Note that if the road surface or ground are slippery (due to rain, snow, sand, etc.), there is a risk that the drive wheel of your pedelec may skid and slide.

Maintenance and care



Before performing any kind of work on your pedelec, turn off the electric unit and remove the battery. Not doing so may result in serious injury and/or electric shock.



Only perform operations described in this manual. Do not change the device. You should not disassemble or open any modules. If in doubt, always contact a specialist dealer.



Keep the all components of the electrical system clean. Clean gently with a damp, soft cloth. The components must not be immersed in water or cleaned with a water jet or steam jet. If the components are no longer functional, contact your dealer.



The frequency of maintenance will vary depending on riding conditions. Periodically clean the chain using an appropriate chain cleaner. Do not use alkaline or acidic cleaning agents to remove rust under any circumstances. If such cleaning agents are used, they may damage the chain and serious injury may result.



Only have maintenance, repairs and repair work carried out by qualified personnel and only with original spare parts. In case of a flat tire or other technical problem, contact a qualified professional to carry out the repairs.

- Open live parts should only be maintained and cleaned at a specialist pedelec shop.
- Only replace parts of your pedelec with original parts or parts approved by the manufacturer. Otherwise, warranties or guarantees may be voided.
- Remove the battery before cleaning your pedelec.
- Ensure that you do not touch or accidentally connect contacts when cleaning or maintaining the battery. You are at risk of injuring yourself or damaging the battery if these are live.

- Cleaning with a high-pressure device may result in damage to the electrical system. The high pressure can cause cleaning fluid to seep into sealed parts and damage them.
- Avoid damaging cables and electrical parts. When this occurs, the pedelec must be decommissioned until a specialist retailer has examined it!

Wear and tear and warranty



The pedelec and all mechanical parts are subject to wear, tear and heavy use. Different materials and parts may react differently to wear or permanent strain. If a component is used for longer than it is designed for, it may suddenly stop working and possibly lead to injury or cause additional damage. Any kind of tear, puncture or colour change seen in a highly used area indicates that the component's use has reached its limit; the component should in this case be replaced.

Keep in mind that pedelec parts are subject to greater wear than those of a bicycle without an additional drive. This is due to the greater weight of the vehicle and the higher average speed that is achieved through the propulsion. This higher level of wear is not a material defect and is not subject to warranty.

* see page 45

Typical parts affected by this are:

- Tires
- Brake pads
- Components of the drive
- Spokes

The battery is subject to ageing and is therefore also a wearable part. Please note that the battery gradually loses its capacity depending on its age and operating life. Take this into account when planning journeys and ensure that you switch to a new battery in good time. Replacement batteries are available from your specialist pedelec retailer.

Adjusting the pedelec to the rider

The seat post, seat, stem and handlebars can be tightened and secured with quick releases or bolted connections.



For detailed information, please read the operating instructions supplied by the manufacturer. Only specialists should work on your handlebars and stem.

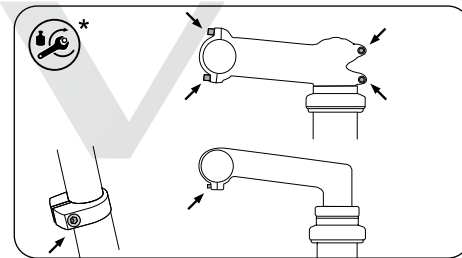

Possible positions for adjusting bolted connections

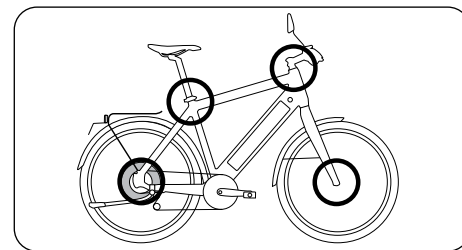

Possible positions of quick releases and through axles

Using quick release levers and through axles

Quick release levers and through axles are systems installed on the pedelec in place of bolted connections. They consist of two parts: the quick release lever, which provides the necessary clamping force, and the adjustment nut, which allows you to regulate the tightness. You can change the tightness of your quick release when it is open.



Quick releases should be closed with the correct tightness. To close the lever correctly, pressure should be felt when it is half closed and, at the end, the ball of the thumb needs to be used to completely close it.

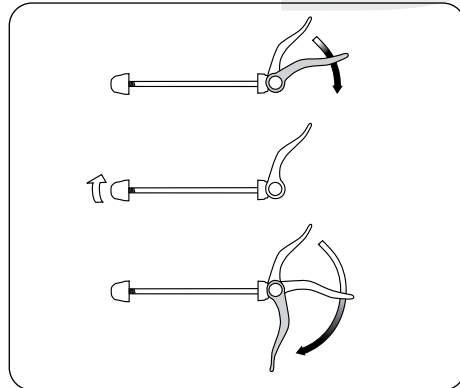

Loosening the adjusting nut

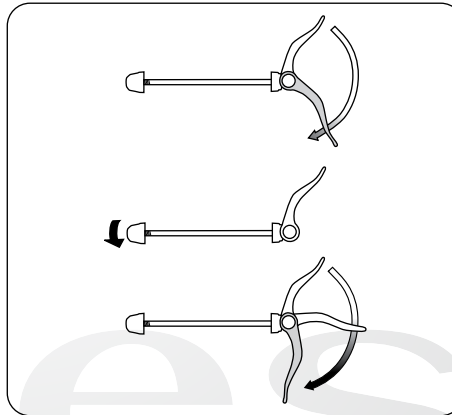

Tightening the adjustment nut



- All quick releases must be firmly closed before you set off.
- Make sure all quick release levers and through axles are securely and properly fastened – even if the pedelec has only been left unattended for a short time.
- A closed quick release fastener must be folded in close to the frame, fork or seat post.
- When closed, the tip of the quick release lever must always be pointed backwards. This way, it won't open during the ride.

- The quick release lever for the wheel has to be installed on the opposite side to the brake disc to avoid burns from contact with the hot brake disc. The clamping force of the quick release can also be reduced if it is heated by the brake disk.



When you park your pedelec, attach wheels or other parts of your vehicle that are attached with quick release fasteners in with your bike lock.

Through axles



If your pedelec has one or several quick release axles, please read the corresponding instructions provided by the component manufacturer on how to operate and service these parts.

In current chassis, quick release axles may be used in place of quick releases or bolts. These usually function like quick release levers and should be operated as such.

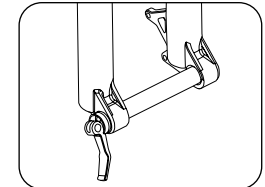

Slide-in shaft in the fork ends, without hub, Rock Shox fork®

The skewer is screwed into the dropout and fixes the hub inside the fork or into the dropouts in the

frame. The hub and the skewer may be fastened with a quick release lever, which is operated just like a normal quick release. Systems in which the shaft is only inserted or screwed in and then fastened with a screw also exist.



Refer to the attached component manufacturer instructions and ask your specialist retailer to explain the system to you in detail.



Inappropriately installed wheels may shift while you are riding or become detached. This may damage the pedelec or even expose the rider to severe and life-threatening injuries. It is therefore important to take note of the following instructions:

- Ensure that the dropouts and quick release mechanisms are clean and free of dirt and impurities.
- Ask your specialist dealer to explain in detail how to correctly fasten your wheel with the quick release axle system.
- Firmly fasten the front wheel.
- Never ride your pedelec when you are not sure if the front wheel has been appropriately fastened and cannot come loose.

Installation

Place the wheel in the dropouts. The hub must be firmly pushed into the dropout. Close the attachment mechanism.

For vehicles with disc brakes, ensure that the brake disk is properly inserted into the calliper. Ensure that neither the brake disk nor the hub or the brake disk fastening screws rub against the lower parts of the fork.



If you do not know how to adjust your pedelec's disc brakes, read the instructions provided by your brake manufacturer.

Installing the pedals

If your pedelec was supplied without the pedals pre-installed, these have to be attached with the correct spanner or wrench. Please note that the pedals have to be screwed in in different directions and secured with a high mounting torque (see page 45). Coat both threads with assembly lubricant.

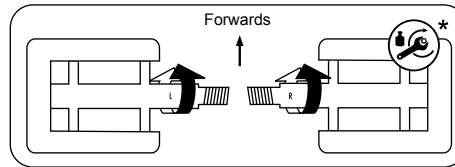

For assembly and handling of clip-in pedals and flat pedals, please read the manufacturer's assembly and operating manual.



Read the attached instructions of the component manufacturers when using pedals with clips and straps. Practice taking your feet in and out of the hooks and operating the strap releases in a safe place. Tightened straps do NOT release the feet! This can result in falls and injury.

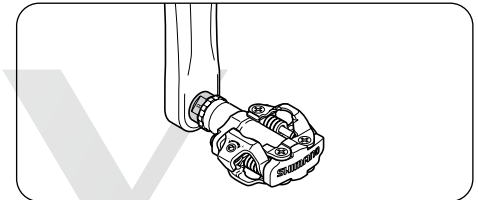

Source: Shimano® techdocs



Ensure that you have read the manufacturer's instructions before using magnetic or clipless pedals.



Practice clipping your shoes in and out of the pedals' locking system before your first ride in a quiet, safe place. Any trouble releasing from clipless pedals is a safety risk.

* see page 45



With system pedals, you can adjust how much force you need to release the shoe from the pedal. Please test this on your first ride with a setting that releases very easily! Regularly clean your magnet pedals and keep them in good condition with a suitable spray lubricant.



If your pedelec has rubber or plastic cage pedals, please familiarise yourself with the grip which these offer. In wet conditions, rubber and plastic pedals can be very slippery!

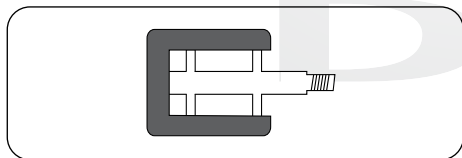

Adjusting the saddle

Before you use your pedelec for the first time, the saddle position has to be adjusted to suit your body size. This will allow you to ride your bike safely.

The height, horizontal orientation and inclination must be adjusted for the saddle and the height and orientation of the stem for the handlebars.

Finding the correct seat height

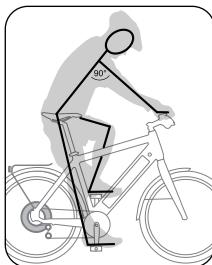

Correct seat height

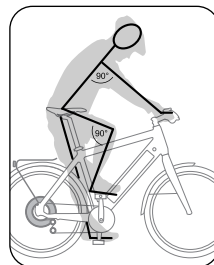

Knee joint of the upper leg at min. 90°, angle of arm 90°

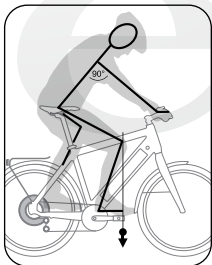

The knee should be above the axle of the front pedal



Never pull the seat post further out than the maximum mark on the tube frame! If there is no maximum mark, the seat post should always be at least 7.5 cm deep in the tube frame.

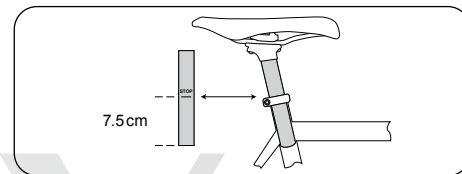

You are using the correct foot position for riding when your foot's widest point is above the pedal axle.

If you are using clipless pedals, you should adjust the pedal plates to ensure that your foot is in this position. The widest part of your foot should be above the pedal axle.

This prevents damage to the musculoskeletal system and ensures maximum transmission of force.

The minimum saddle height should be adjusted according to the rider's individual body size. He should be able to cycle without it interfering with his health or safety.

The seat post's maximum extension should allow it to remain securely clamped into place by the bolt.

Ask your specialist retailer for advice on these last two points.

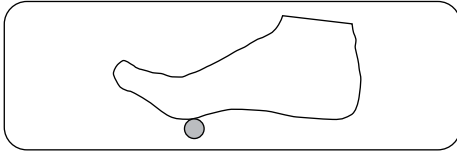

Children and people who feel insecure when riding should be able to touch the ground with their toes. Otherwise, when stopping you run the risk of falling and serious injury.

Adjusting the saddle tilt

If you have adjusted the saddle height, the saddle inclination should be checked and adjusted as well. The surface of the saddle should always be approximately parallel to the ground. You can perform this adjustment when the seat clamp bolts of the seat post have been undone.

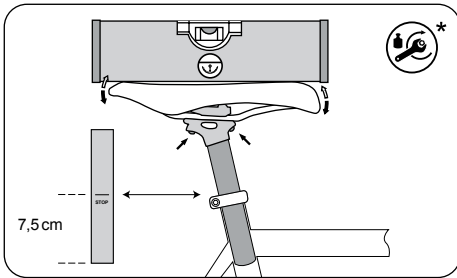

Patented seat post with two-screw locking mechanism

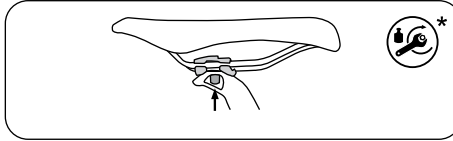

Patented seat post with one-screw locking mechanism

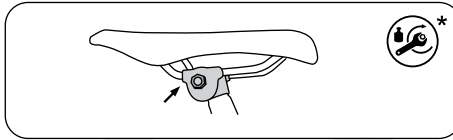

Attachment with seat clamp



Before you start riding, please test to see if your seat post and seat are secure. To do this, grasp the saddle at the front and back and attempt to turn it. It should not move.

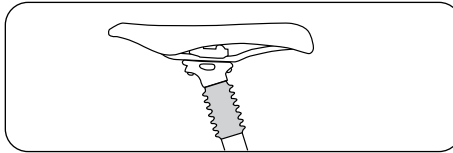

Suspension seat post



For information concerning the installation and service of threaded and telescopic seat posts, read the manufacturer's service manual.

On bikes with rear wheel suspension and whose seat post tube is open at the bottom, the seat post must never touch the suspension element, even when the rear suspension is compressed!

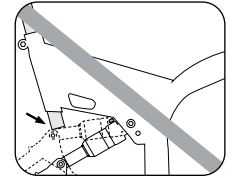
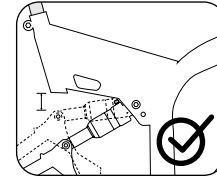

Handlebar position/adjusting the stem



For detailed information, please read the operating instructions supplied by the manufacturer.



Only specialists should work on your handlebars and stem.

Various types of stem are used on pedelecs:

Threadless stem

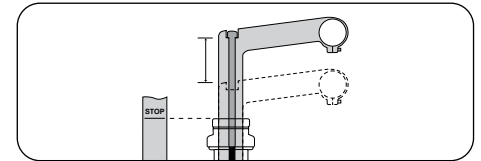

Height adjustment possible

* see page 45



Changing the position of the stem also changes the position of the handlebars. You should always be able to safely reach and use grips and controls. Please ensure that all cables and lines are long enough to allow you to turn the handlebars in every possible way.

A-head stems

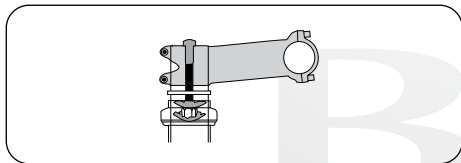

Height change possible as follows:

- Exchange of fitted spacers under or above the stem
- Turning of the stem
- Exchange of the stem

Quill stem

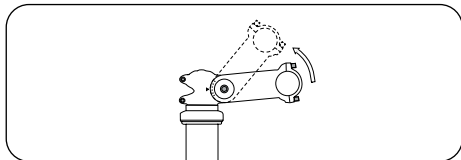

Adjustment of stem tilt possible

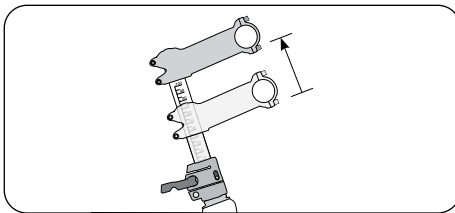

Adjustment of stem height possible

Setting up the brake levers

Set up your brake levers in such a way that you can safely apply them and brake comfortably. Please familiarise yourself with which lever operates which brake!

Some brakes are now equipped with power modulators. This guards against "overbraking" and any dangerous locking of the wheels. If these are adjustable, you will find a description in the modulator manufacturer's operating manual.



When using power modulators, the braking force can increase sharply if you squeeze the brake levers hard or all the way to the end of their leverage. Please familiarise yourself with this new braking behaviour. Ensure that you receive and read the manufacturer's operating manual.



The brake levers should be set up so that your hands can safely and comfortably apply them as a straight extension of your arms.

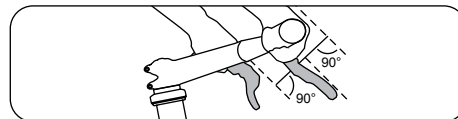

Check the position of the brake levers before your first ride. In hub gear systems, the right brake lever on the handlebars is generally the front brake. However, in chain gear systems, this brake lever is located on the left-hand side. If you would like to swap the position of the brake levers on the handlebars, please contact a specialist retailer.

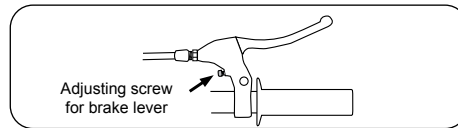

In order to be able to apply the brake lever if you have smaller hands, in some models it is possible to position the brake levers closer to the handlebars using special equipment.



For more on this, please read the enclosed instructions from the component manufacturer.

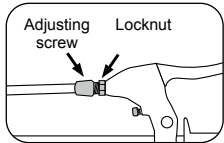

Mechanical brakes are usually able to be readjusted by turning the adjustment screw located on the handle. Loosen the adjustment screw from the handle until the brakes becomes firmer. Secure the adjustment by tightening the locknut on the handle.

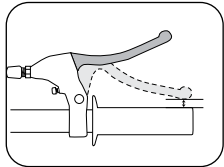

Set up the cable tension in such a way that the brake levers do not touch the handlebar grip, even when they are applied to their fullest extent!



If you adjust the position of the brake or gear levers, make sure that they do not interfere with each other's function.

Children

Children and pedelecs

Inform yourself on whether the child is old enough to ride the bike and has the necessary license to do so before allowing him or her to ride the pedelec. Pedelecs may only be ridden by children that are of legal age and possess the necessary permit.



Don't let children who are unattended ride the pedelec without first thoroughly instructing them on how to use it. Explain to children the dangers of using electrical devices.

Carrying children/trailers for children

- Please only use safe, certified children's seats.
- The child must wear a helmet, their feet must be tucked in and protected from any possible contact with moving parts, such as spokes.
- A child seat changes the way your pedelec behaves when riding. Take note of the longer braking distances and the steering which could be less stable. Practice riding with a child seat in a safe area before taking to public roads.



Only install children's seats on pedelecs which are intended for this kind of equipment. Carbon fibre frames and components are not suitable for the use of children's seats. Never attach a children's seat to the seat post. Wrap and protect all springs and moving parts on the saddle and seat post. Please ensure that your child cannot trap their fingers anywhere. This could result in injury!

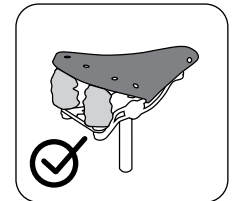
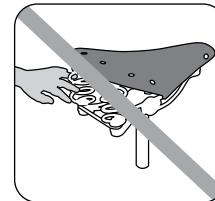
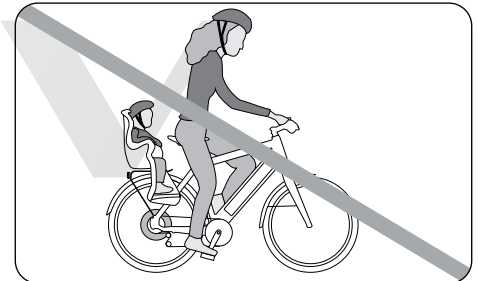



In Germany, children may only be transported in child seats up to the age of 7 years. Find out about the legal regulations which relate to the age of the child and the rider.



If additional equipment was delivered with your pedelec which was not pre-assembled, please ensure that you read the manufacturer's instructions.

Child bike trailers:



Please comply with the manufacturer's instructions supplied with the trailer.

- Take no chances in terms of quality when buying bike trailers for children.
- Only install child bike trailers on pedelecs intended for this purpose using mounting parts which are supplied or approved by the manufacturer.
- It is easy not to see a child bike trailer in traffic! Use a brightly coloured flag and approved light system to ensure that it is easily seen. Ask your specialist retailer about safety equipment.

- Notice that trailers make the pedelec much longer than usual. Riding a pedelec around corners with a trailer is different to riding without. You must keep this in mind when riding in traffic. Before riding on public roads, practise riding your bike with an empty trailer in a safe and quiet environment.

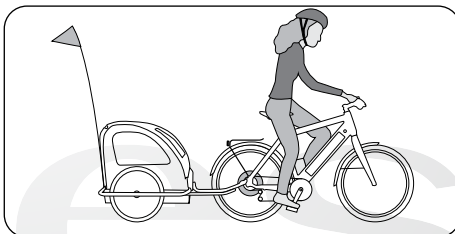

Only install child bike trailers on pedelecs intended for this purpose using mounting parts which are supplied or approved by the manufacturer.



Check whether the manufacturer provides a maximum permitted weight and a maximum permitted speed. If so, these values must be adhered to. Children under 16 are not legally permitted to ride a bike with a trailer in Germany.



Full suspension pedelecs are not suitable for use with trailers and child bike trailers! The bearings and attachments are not designed to withstand this sort of force. This could result in wear and damage with serious consequences.

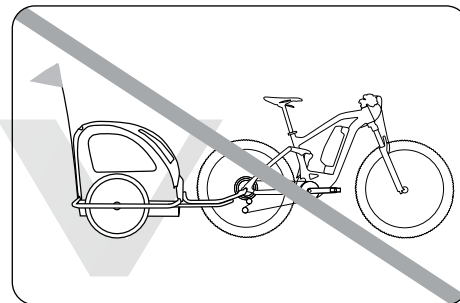

Frame

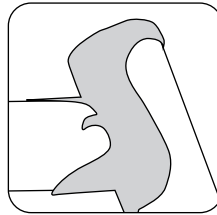
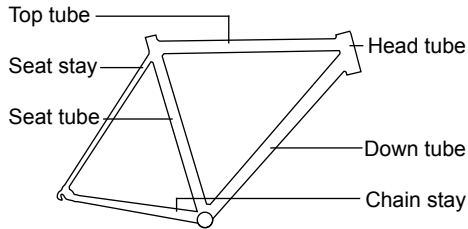

Lugged steel frame

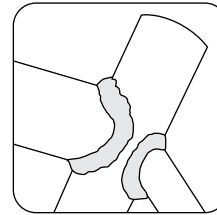

Welded aluminium frame

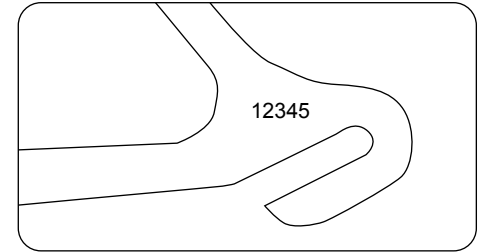

Frame shapes vary according to the type and function of the pedelec. Thanks to the evolution in materials and construction techniques, it is nowadays possible to produce all shapes of frames safely so they perform stably during riding. So despite a low step-through, you can still be sure that your pedelec is always safe on the roads, even with luggage on board.

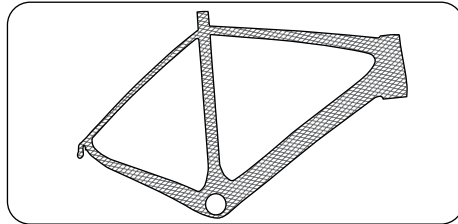

Carbon frame



If your e-bike is stolen, it can be identified using its frame number. Please always note down the full number in the correct order. If you do not have the number it will be impossible to make a unique identification. In the documentation you received from the retailer when you purchased your pedelec, there is also a section where the frame number is entered. The frame number can also be engraved on various parts of the frame. It is often located on the seat tube, on the drop-outs or on the bottom bracket shell.



Under no circumstances should you ride with a bent or broken frame. Never attempt to repair damaged parts yourself. Otherwise, there is a danger of accidents. Faulty parts should be replaced by a specialist retailer. Please only ride your pedelec again when the parts affected have been replaced. Faults on the frame or other parts can cause accidents. If your pedelec does not ride in a straight line without any problems, this can be due to a bent frame or fork. Please contact a specialist retailer to have the frame and fork checked and possibly to have the bike realigned.

Suspension

If your pedelec is equipped with suspension elements, they must be adjusted to suit the rider's weight and intended purpose. Expertise and experience are needed to perform this kind of work. Therefore, if you need to adjust the suspension, it is best to bring your bike to a shop.



Carefully read the enclosed manual concerning the suspension system to your pedelec.

A typical suspension fork can look like this:

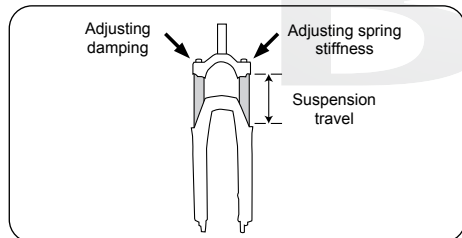

Any adjustment to a suspension fork must be carried out in accordance with the suspension fork manufacturer's operating manual. As a general rule, the suspension fork should show noticeable movement when riding over uneven surfaces but should not "knock" (i.e. compress all the way to the limit stop).

A suitable basic set up would see the suspension pushed in around 10–15% (cross country), 15–20% (touring) or 25–33% (enduro, freeride, downhill) of the spring travel when the rider is sitting normally on the pedelec.



Suspension forks can only function effectively if they are regularly cleaned. Purpose-made cleaning products or warm water with washing up liquid are suitable here. Specialist retailers also stock suitable spray lubricant for greasing your suspension regularly, both after every clean and otherwise. The same applies for suspension seat posts.



Most suspension seat posts can be adjusted to the rider's weight. However, in most cases this requires the seat post to first be extracted from the frame. Contact a retailer if you have any questions about this.

Suspension frames and suspension elements

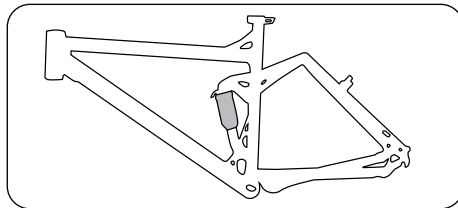

In this case, the frame's rear fork is flexible and a shock absorber provides suspension and damping. Some shock absorbers use a metal spring to absorb vibration, while others do this with an air chamber.

The absorptability, which regulates the speed of compression and stretching, can be adjusted in high quality shock absorbers.

A typical spring element can look like this:

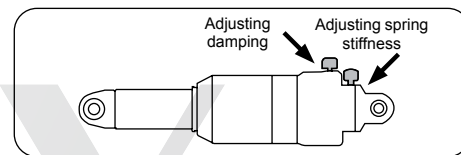

For detailed information, please read the enclosed instructions from the manufacturer.



Avoid washing your pedelec with a high-pressure cleaner as the cleaning fluid can penetrate sealed parts due to the high pressure and then eventually destroy them.

The shock absorber's sliding pistons and gaskets should be carefully cleaned with a soft cloth as part of your regular pedelec cleaning routine. Spray lubricant on the running surface of the shock absorbers and gaskets helps keep the system working effectively. Special spray lubricant is available for this purpose.



You should regularly check the links of the rear fork for play. Grip the frame securely and attempt to move the rear wheel from side to side. You can also test for play in the shock absorber attachment by rapidly lifting and dropping the rear wheel. If you a) notice play anywhere or b) hear rattling, you should immediately take your pedelec to be checked by a specialist retailer. Do not use your pedelec until it has been repaired.



The functionality and secure fit of the suspension parts are vital for your safety. Clean and check your full suspension pedelec on a regular basis! Warm water with a little washing up liquid or gentle cleaning agents are suitable for cleaning this part of the pedelec.



Tighten all screws to the recommended torque to avoid screws falling out or breaking and parts falling off (see page 45).



Full suspension pedelecs are not suitable for use with trailers and child bike trailers! The bearings and attachments are not designed to withstand this sort of force. This could result in wear and damage with serious consequences.



If you have a full suspension frame with a short seat tube which is open at the bottom, the seat post can only be lowered to the point that it does not touch the spring element when it uses its full travel.

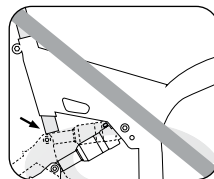
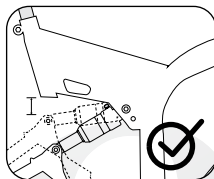

Maintenance and upkeep



Please have your pedelec checked by a specialist retailer on a regular basis. They recognise damage and worn components and can advise you on the choice of a replacement. Refrain from repairing key parts yourself (frame, fork, handlebars, stem, headset, brakes, lights).



Modern pedelec technology is high tech! Working on pedelec parts therefore requires expert knowledge, experience and specialist tools. Do not do any work on your pedelec yourself. Take your pedelec to a specialist workshop if it is in need of repair, maintenance or restoration.



The pedelec and all mechanical parts are subject to wear, tear and heavy use. Different materials and components can react to wear and tear from heavy use in different ways. If a component is used for longer than it is designed for, it may suddenly stop working and possibly lead to injury or cause additional damage. Any kind of tear, puncture or colour change seen in an overused area indicates that the component's use has reached its limit; the component should in this case be replaced.



Screws and torque wrenches

When working on the pedelec, please ensure that all screws are tightened to the correct torque. On many components, the torque required for mounting is printed.

Measurements are given in Newton metres (Nm) and applied with a torque wrench. It is best to use a torque wrench that displays the tightening torque as it is in use. Otherwise screws can snap or break. If you don't own a torque wrench then you should always leave this work up to a specialist retailer! A table listing the most important torques for bolted connections is provided on page 45.

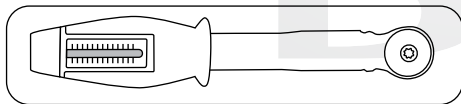

Torque wrench



Wear suitable protective clothing, protective gloves and protective goggles during all installation and maintenance work. Otherwise, dirt or injuries that may be caused by lubricants and auxiliary devices for the motor among other things may result.

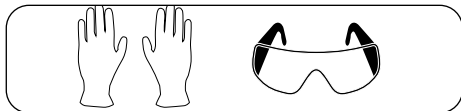

Chain

Cleaning the chain

To ensure it works effectively, the pedelec chain has to be cleaned and greased regularly (see page 44). Dirt can be removed when washing the rest of the pedelec. Otherwise you can clean the chain by rubbing it with an oily cloth. If it is clean, it should be lubricated at the joints with the appropriate lubricant. After a while, the excess lubricant should be wiped off.

Chain tension



To ensure that the chain and gears work safely, the chain has to have a certain level of tension. Derailleur gear systems tense the chain automatically. In the case of hub gears which were installed without a chain tensioner, chains which are too loose have to be tightened. It might otherwise jump off the gears and lead to a fall.



In the case of pedelecs with adjustable dropouts, the mounting screws of the axle housing should be loosened and tightened, and not the axle nuts. If the bottom bracket shell contains an eccentric bush, please tighten the chain according to the instructions provided by the corresponding manufacturer.



Be absolutely sure to fasten the axle nuts and the brake arm correctly!

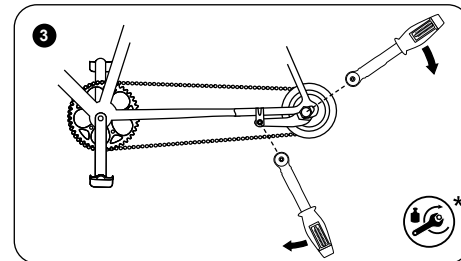
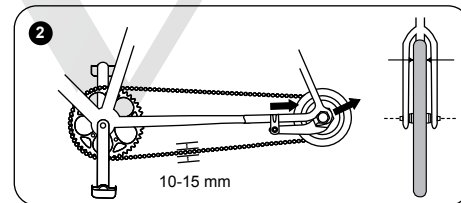
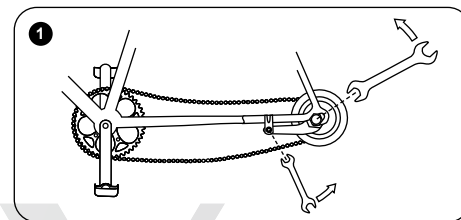



Dirt and permanent strain wear the chain. The chain should be replaced as soon as it can be significantly lifted (approx. 5 mm) from the front chain ring. Modern chains for derailleur gear systems no longer have chain connectors. Specialised tools are needed to open/change/close them. This work should be carried out by a professional or a specialist retailer. Other chains are supplied/assembled with chain connectors. In some cases, these can be opened without the need for tools. These chain connectors can also be used to repair a damaged chain on a ride if they have the correct width for the drivetrain.

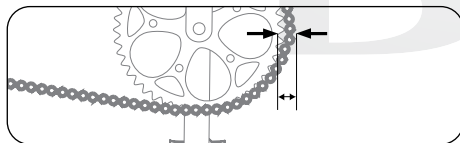

Determining chain wear

You can determine chain wear with a specialised tool.

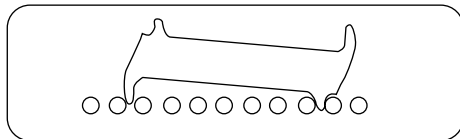

Measuring chain wear. If it is a new chain, the measuring tool will not sink in between the chain links.

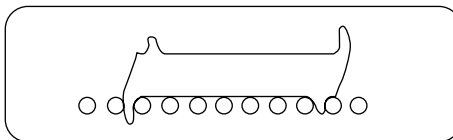

If a chain is as worn as this one, the measuring tool will sink in completely. This chain must be replaced.



If a worn chain is not replaced, the cassette and chain wheel will become excessively worn. This may result in earlier breakdowns and higher costs.

Belt drive

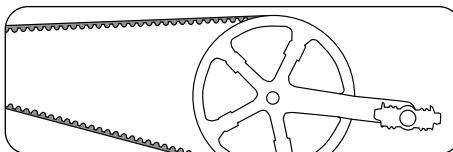

If your pedelec is equipped with a belt drive, please read the attached component manufacturer's operating instructions before first use.

Cleaning the belt



In order to extend its lifespan, we recommend cleaning the belt with water or a hand brush (e.g. after riding through mud or dirt). Residue on the belt or belt pulleys can result in increased wear and noise (e.g. squeaking or creaking).

Check your belt drive for damage, material deformation and cracks each time you clean it, and, if in doubt, consult a specialist retailer for help with troubleshooting.

If you still notice any noise despite a thorough cleaning, a thin layer of dry silicone spray can be applied to the inside of the belt. This protects it against further build-up, reduces friction on the belt and reduces noise.

Handling



Please refer to the following handling instructions to extend the belt's lifespan. Improper handling may result in damage to the belt and necessitate a replacement!

- Do not bend or twist it
- Do not turn it inside out
- Do not bunch or coil it
- Do not use it as a belt whip
- Do not use tools or sharp instruments when handling the belt

- Do not use levers to place the belt on the belt pulley.
- Do not use tension or guide pulleys
- Do not oil



Ensure that the belt line, pulley angles and belt tension are in compliance with the specifications outlined in the manufacturer's operating instructions.

Wheels

Checking the wheels

The pedelec is connected to the ground by its wheels. The wheels are subject to a great deal of strain through the uneven characteristics of the ground and the weight of the rider.

Thorough checks and centring work on the wheels is undertaken before they are shipped from the manufacturer. However, during the first few kilometres of riding, the spokes bed in.

- After the first 100 kilometres, the wheels need to be checked by a specialist and centred again if required.
- The tension of the spokes should be checked at regular intervals. Loose or damaged spokes must be replaced or centred by a specialist retailer.

The wheels can be fixed into the frame and fork in different ways. Commonly, the wheel is attached with an axle nut or a quick release. In addition, there are also various slide-in connections which are screwed on or fixed with various quick release systems.



If a slide-in shaft is fitted on your pedelec, you can find more information in the enclosed operating manual or on the manufacturer's website on the Internet.



All screws must be tightened with the correct torque. Screws may break and parts may become loose if they are not tightened with the correct torque (see page 45 "Torques for screw connections").

Checking the hubs

You can check the hub bearings as follows:

- Lift both wheels up from the ground by first lifting the pedelec at the front then at the rear. Spin each wheel to start them turning.
- The wheel should continue to turn and then slow evenly. If the wheel suddenly stops, the bearing is defective. One exception is front wheels with a hub dynamo. These have a slightly higher resistance. This is not noticeable when cycling, but can be seen in this test.
- The hub bearing should not exhibit play. Pull the wheels from side to side in the fork and frame to check if they are loose. No play should be noticeable here.
- If the wheels can be slightly moved in their bearings or are difficult to turn, the hub bearings have to be set up by a specialist retailer.

Wheels/Tires

Clean the braking surfaces regularly according to the inspection plan, page 42. Check the wear markers during this process.



Modern rims (from 24") indicate when they are worn from braking. These indicators take the form of embossed or coloured points or lines on the brake surfaces of the rims. When these disappear, you should no longer use the rims. There are also similar indicators which only appear after a certain level of wear. At the very latest after two pairs of brake rubbers have been worn through, please have the rims checked by a specialist retailer.

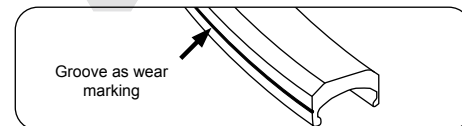

Rims undergo high strain and are safety-relevant parts. They will become worn from riding. If you see any damage, do not ride using this rim. Have them checked by a specialist retailer and replaced if required. Wear can weaken rims and lead to falls and serious accidents.



Rims made of composite materials such as carbon fibre in particular require special attention. Friction caused by rim brakes, as well as just simply riding the bike, puts a high amount of strain on the bike.

- Only use brake pads that are designed for use on the rims' materials!
- Before every ride, check rims and wheels made of composite materials for wear, deformation, cracks and chipping!
- If you notice any changes, do not ride with this part until it has been inspected by your specialist retailer or manufacturer and found to be in good condition!
- Never expose carbon fibre parts to high temperatures. Even intense sunlight (e.g. when the wheel is stored in a vehicle) can produce high temperatures. This may result in damage to the structure of the part. Failure of parts, falls and very serious injuries could result.



The permitted tire pressure may not be exceeded when inflating the tires. Otherwise this could lead to a tire bursting. The tires must be inflated to at least the stated minimum tire pressure. If the tire pressure is too low, there is a possibility that the tire could free itself from the rim.

On the side surface of the tire, there is information on the maximum permitted tire pressure and generally also on the minimum permitted tire pressure. If you replace the tires, only exchange them for the same model with the same dimensions and profile. The riding experience can otherwise be negatively affected.

If the inflation pressure rating indicated on the tire and on the rim differ, the lowest maximum pressure and the highest minimum pressure apply.



Tires are available in various dimensions. The tire dimensions are provided with standardised information.

Example 1: "46-622" means that the tires have a width of 46 mm and the rim has a diameter of 622 mm.

Example 2: "28 x 1.60" states that the tire has a diameter of 28 inches and a width of 1.60 inches.

Tires and tire pressure

The amounts for the recommended tire pressure can either be named in bar or PSI. The following table presents the conversions for the usual pressure levels and shows which tire widths these pressures should be applied to.

Tire width	Recommended tire pressure
20 mm	9.0 bar 130 psi
23 mm	8.0 bar 115 psi
25 mm	7.0 bar 100 psi
28 mm	6.0 bar 85 psi
30 mm	5.5 bar 80 psi
32 mm	5.0 bar 70 psi
35 mm	4.5 bar 65 psi
37 mm	4.5 bar 65 psi
40 mm	4.0 bar 55 psi
42 mm	4.0 bar 55 psi
44 mm	3.5 bar 50 psi
47 mm	3.5 bar 50 psi
50 mm	3.0 bar 45 psi
54 mm	2.5 bar 35 psi
57 mm	2.2 bar 32 psi
60 mm	2.0 bar 30 psi



You must observe the information provided by tire and rim manufacturers. This could possibly be different from the tire pressures listed here. Not adhering to these guidelines can lead to damage to your tires and inner tubes.



You should also regularly check your tires. The lowest and highest authorised pressures can be found on the side of the tire. Please adhere to these values, otherwise the tire may detach from the rim or burst.

If the inflation pressure rating indicated on the tire and on the rim differ, the lowest maximum pressure and the highest minimum pressure apply.

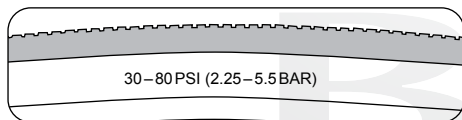

Example of tyre pressure information



Tires are wearable parts. You should therefore regularly check the pressure, tread and condition of your tires. Not every tire is suitable for every purpose. Allow a specialist retailer to advise you when selecting tires.



When replacing original tires or cranks, ensure that there is sufficient space between the tire and your shoe. Failure to do so may result in accidents and serious falls.



Your pedelec can only function safely and effectively if you replace parts with suitable, authorised replacements. Please consult your manufacturer, importer or specialist retailer for advice on suitable replacement parts.



Only replace broken or worn key parts with original replacement parts from the manufacturer or parts approved by your manufacturer. This is mandatory in the case of light systems, while the manufacturer's warranty is usually nullified if you install non-approved replacement parts. Ask your specialist pedelec retailer for advice on suitable material.



If you install non-original or wrong replacement parts, this can lead to severe loss of function! Tires with poor grip or safety, brake pads with a low friction coefficient and incorrectly installed or poorly made lightweight components can all lead to potentially serious accidents. The same applies for improper assembly!

Flat tire repair for conventional tires



Contact a pedelec dealer or an authorised workshop to fix flat tires. You will need specialised knowledge and specialist tools, especially when removing the drive wheel and disconnecting the motor connections. If you still want to perform the repair yourself, please obtain prior instruction (e.g. from a specialist retailer).

Wheel removal and installation for wheels without a hub motor



Always turn off the electrical system first and remove the battery before performing any kind of work! Failure to do so may result in electrical shock or serious injury.

To repair a punctured bike tire, you will need:

- Tire levers (plastic)
- Spanner or wrench (for wheels without quick release levers)
- Air pump
- Spare tube

1. Opening brakes

Please read the instructions in the chapter "Brakes" (page 36).

2. Removing the wheel

- If your pedelec has quick release levers or axles, open them (see page 20)
- If your pedelec has hex nuts, loosen these with a suitable spanner anti-clockwise.

You can then remove the front wheel according to the steps listed above.



Source: Shimano® techdocs

The following applies for rear wheels:

- If your pedelec uses a derailleur gear system, change gear to the smallest sprocket. In this position, the rear derailleur poses the least hindrance in removing the wheel.
- If your pedelec has quick release levers or axles, open them (see page 20).
- If your pedelec has hex nuts, loosen them in anti-clockwise direction with a ring spanner in the correct size.
- Pull the derailleur backwards a little.
- Lift the pedelec slightly.
- Tap the wheel from above with the palm of the hand.
- Take the wheel out of the frame.



If your pedelec has hub gears, please consult the instructions supplied by your manufacturer for removing the wheel.

Types of pedelec inner tube valves:

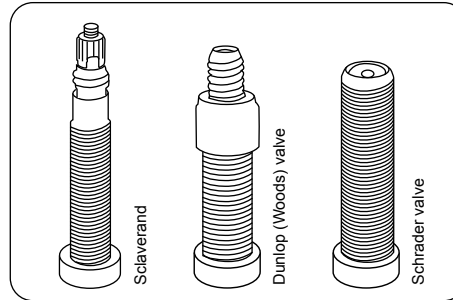

3. Disassemble tire and inner tube

- Remove the valve cap, the locking nut and possibly the union nut from the valve. For Dunlop valves, remove the valve core.
- Let the remainder of the air out of the tube.
- Insert the tire lever opposite the valve on the inside of the tire.
- Insert the second tire lever approx. 10 cm from the first, between the rim and tire.
- Lift the tire wall over the edge of the rim.
- Lever the tire as often over the rim as is necessary for loosening the tire all around the rim.
- Take the tube out of the tire.

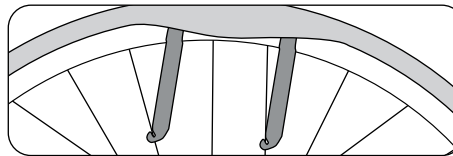

4. Fit the tire and new inner tube



Avoid foreign objects getting inside the tire. Make sure that the tube is wrinkle-free and does not get pinched anywhere. Ensure that the rim tape covers all spoke nipples and does not show any sign of damage.

- Push the valve through the valve hole in the rim and place the hose inside the tire.
- Use the ball of the hand to press the other side of the tire completely over the edge of the rim.
- Verify that the tube is properly seated.
- In the case of Dunlop valves: Replace the valve core in its seat and tighten the union nut.
- Pump a little air into the tube.
- Check that the tire is properly in place and turns straight using the control ring on the side of the tire. Correct the tire's position by hand if it does not turn straight.
- Pump air into the tire up to the recommended pressure.



When mounting the wheel, pay attention to the rotational direction of the tire.

5. Mounting the wheel

Reattach the wheel securely back in the frame or fork with the corresponding quick release, bolted connection or full floating axle mechanism.



If your pedelec has disc brakes, please ensure that the brake discs are correctly secured between the brake pads.



Read the gear manufacturer's instructions to correctly and safely assemble and set up derailleur gear systems, hub gears and combined hub and derailleur gear systems.



Tighten all screws to the recommended torque. Otherwise the screws could break and parts could fall off (see page 45).

- Connect the brake line, attach it or close the brake quick release.
- Check whether the brake linings touch the brake surfaces.
- Carry out a brake test.

Brakes



Normal operation wears down brake rubbers and brake pads. You should therefore regularly check the condition of your braking system and brake pads. Replace worn brake pads in good time! Ensure that rims and brake discs are clean and free of any oil.

Modern pedelecs can be equipped with a variety of different braking systems. There are different systems such as:

- Rim brakes in the form of V-brakes, cantilever or side-pull caliper brakes

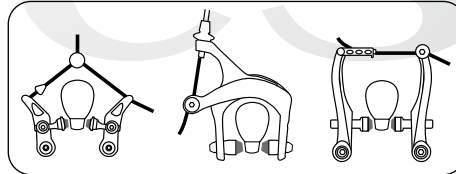

- Hydraulic rim brakes

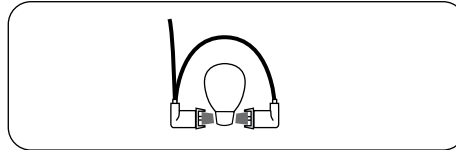

- Disc brakes with hydraulic or mechanical operation

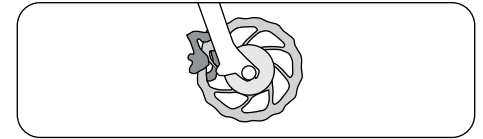

Various versions of disk brakes are available for racing and cyclo-cross bikes. Always read the enclosed instructions from the parts manufacturer before the first ride. Make sure you practice and get used to operating the brakes on safe terrain before going on your first bike ride!

- Drum brakes

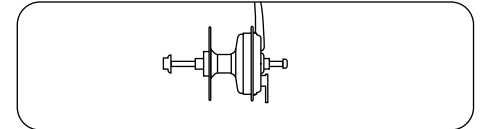

- Rollerbrakes

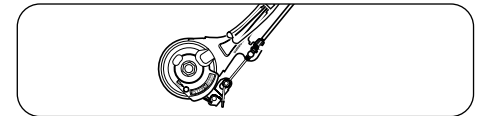

Source: Shimano® techdocs



Almost all modern brakes provide considerably more braking power than was available for bicycles/pedelecs in the past. Carefully familiarise yourself with the brakes, practise using them and emergency braking, starting on safe ground with no traffic before setting off onto roads with traffic.



If you are riding on a long or very steep slope, do not brake continuously or only use one brake. This could lead to the brakes overheating and loss of braking force.



You are braking properly and safely if you use both brakes equally. The only exception is if you are cycling in slippery conditions such as on sand or a smooth surface. You should then exercise great care, slowing yourself down using the rear brake. Otherwise there is the risk of the front wheel slipping out to the side and causing a fall. On very long downhill stretches, you should avoid lightly braking constantly. It is preferable to brake sharply for a shorter time when taking bends or if you are riding too fast. This allows the brakes to cool down in the meantime. This preserves your braking power.



Your pedelec is supplied with the corresponding operating instructions for your specific braking model. You can get more information about the brakes on your pedelec in the operating manual provided by your manufacturer or on the manufacturer's website.



Brakes and brake systems are parts that can be vital to your safety. You should therefore service them on a regular basis. This requires specialist knowledge and special tools. Allow your specialist retailer to do this type of work on your pedelec! Work that is improperly carried out is a risk to your safety on the pedelec!



No oil-based liquids should ever be applied to brake pads, rim brake surfaces, brake shoes or brake discs. These substances reduce the effectiveness of the brakes.

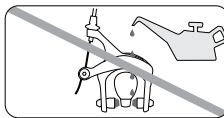
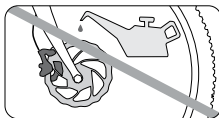

Break pad wear



Normal operation wears down brake rubbers and brake pads. It is therefore important to regularly check the condition of your braking system and brake pads. Replace worn brake pads in good time!

Ensure that rims and brake discs are clean and free of any oil.



After any work on the braking system, perform at least one brake test on safe, empty terrain before you return to traffic.



Have the brake fluid replaced on a regular basis. Check the brake shoes regularly and have them replaced when they are worn out.

Further information can be found in the operating manual provided by the brake manufacturer.

V-brake rim brakes

What to do if the rubber brakes start rubbing against the rim: The spring setting allows you to set the return force in such a way that both brake pads lift evenly from the rim when you release the brake lever. Then, check that the brakes are functioning correctly.

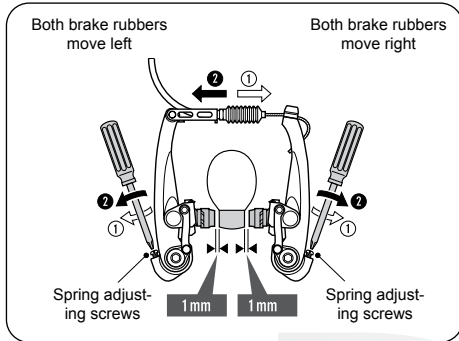

Adjusting the brakes on the rim

Source: Shimano® techdocs

Cantilever brakes

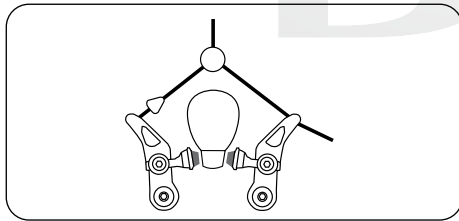

Opening cantilever brake or V-brake

- Hold the wheel with one hand.
- Press the brake arms together against the rim.
- Hang the bowden cable of the brake or the outer sheath of the bowden cable over one of the brake arms.

Side-pull caliper brakes

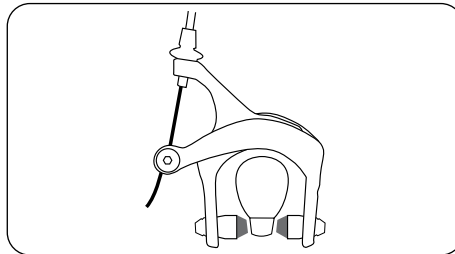

Side-pull caliper brake:

- Open the quick release lever on the brake arm or lever, or:
- If you do not have a brake quick release, deflate all of the air out of the tire. Now the wheel can be pulled out from between the brake pads.

Brake pad wear

The rubber brakes for brake pads are almost all made with grooves and notches. The grooves and notches are used, for instance, to determine the degree of wear on the brake pads. If they are no longer visible, you should change the rubber brakes.

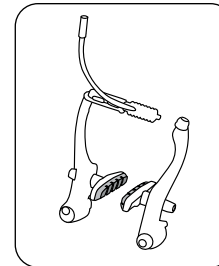

New brake pads

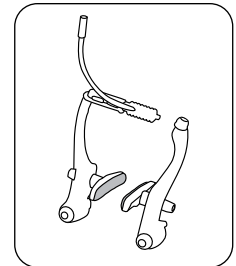

Worn out brake pads

Hydraulic rim brakes

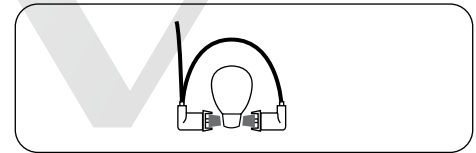

Hydraulic rim brake:

- If your system features a brake quick release, remove the brake unit according to the instructions supplied by your manufacturer.
- If you do not have a brake quick release, deflate all of the air out of the tire.

Disc brakes with hydraulic or mechanical operation

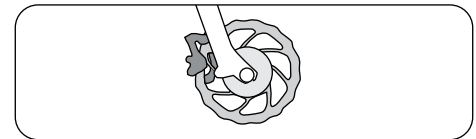

Disk brakes:

- The wheel can be removed without any further preparation.
- Please note: when fitting the wheel, the disk must be slotted between the brake linings of the brake calliper and ultimately be centred without contact.

Bedding in disc brakes

New disc brake pads and brake discs have to be bedded in carefully before you ride the bike for the first time. This process optimises brake performance.



The bedding-in process involves sharp braking. You should be familiar with braking power and the use of disc brakes. Sharp braking without being familiar with brake performance and the operation of disc brakes, can lead to accidents causing severe or fatal injury. If you are unsure, you should have a qualified bicycle/pedelec mechanic perform the bedding-in process for you.

Proceed as follows:

To bed in the brakes, accelerate the pedelec to 30 km/h and then bring the pedelec to a halt by applying maximum braking. Repeat this procedure approx. 20 times. For optimal results, the wheels should not be allowed to lock.



Please do not touch the brake disc while it is rotating or directly after braking. Otherwise injuries or burns may result.



Source: Shimano® techdocs

Air bubbles in hydraulic disc brakes



Avoid permanently braking for long periods, as can be the case during long, steep descents. Otherwise, bubbles may form and a total failure of the braking system may occur. Severe falls and injuries may result.



The brake lever may not be applied if the pedelec is on its side or upside down. Otherwise air bubbles can enter the hydraulic system which could cause the brakes to fail. After transporting the pedelec, check if the pressure point of the brakes seems softer than before. Then slowly apply the brake a few times. By doing this, air can be discharged from the brake system. If the pressure point remains soft, please do not use your pedelec and ask a specialist to remove the air from the brake.



You can avoid this problem by applying the brake lever before transporting your pedelec and then fixing it in this position using a strap. This prevents air from entering into the hydraulic system.



When you come to cleaning the braking system, please first read and follow the instructions provided by the component manufacturer.



In particular, brake discs are subject to wear. Have these safety-related components regularly checked for wear and changed as required by your specialist retailer.

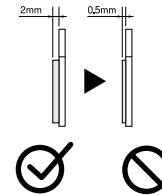

Source: Shimano® techdocs



Please do not touch the brake disc while it is rotating or directly after braking. Otherwise injuries or burns may result.



Source: Shimano® techdocs

Back pedal brakes

If your pedelec is equipped with back pedal brakes, brake by pushing the pedals backwards instead of forwards. This means that your cranks will not freewheel and you are unable to rotate the pedals backwards freely as you otherwise can.

i The most efficient way to brake using back pedal brakes is when the pedals are at the same height parallel to the ground. If one pedal is at the top and one at the bottom, it is difficult to produce enough force to brake effectively.

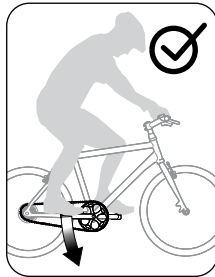
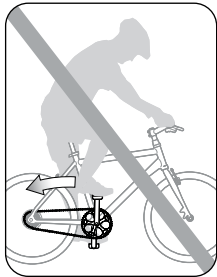

The effectiveness of back pedal brakes can deteriorate substantially on long inclines! This type of braking system can become very hot from continuous braking. You should also use the front brake to slow down on long inclines. Wait until the back pedal brake has cooled down and do not touch the brake drum.

Gear change



This operating manual describes the use of common commercial gear components on a pedelec as an example. If your components are different, you will find specific information in the respective operating manual or on the website of the manufacturer.



If you have any questions about assembling, maintaining, setting up or operating the gears, please contact your specialist retailer.

The gear shifters regulate the necessary cycling power and speed. Using lower gears makes cycling uphill easier and reduces physical exertion when pedalling. While riding in higher gears, more physical exertion is needed to pedal, allowing you to reach higher speeds with lower pedalling cadence.

In general, you should strive to ride at a higher pedalling frequency and in lower gears.

Modern pedelecs can be equipped with a variety of different gear systems.

There are various options:

- Derailleur gear systems
- Hub gears
- Combined derailleur and hub gear
- Automated gear selection

These gears can be operated using various gear levers:

Gear lever, STI Type, for example a Shimano lever

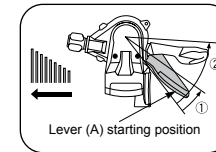

Changing from a smaller to a larger rear sprocket (Lever A)

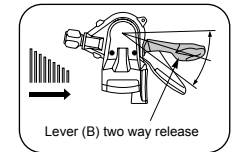

Changing from a larger to a smaller rear sprocket (Lever B)

Combination of hub and chain gear

This type of gear system is offered by SRAM® under the name "Dual Drive". This type of gear system has a 3-gear hub and additional sprockets for conventional chain gear changes.

One of the advantages of this system is that there is no need for a front derailleur and therefore also little angled running of the chain. The hub gear components are operated with a thumb switcher and the chain gear system with a grip shifter or a trigger shifter in the latest models.

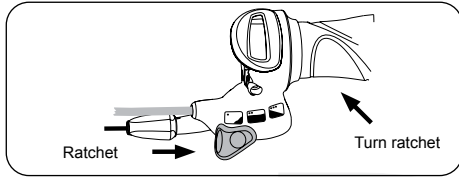

The precise approach when setting up or removing/fitting the rear wheel is explained in the enclosed instructions from the manufacturer.

Automated gear selection

This is a continuous transmission system that allows the driver to switch gears automatically or manually. Select the Automatic mode and simply set your preferred pedalling frequency on the rotary handle; the Harmony system regulates everything else.

The drive automatically and continuously adjusts the transmission, so that your preferred pedalling frequency is always maintained.

Select the Manual mode and directly regulate the continuous transmission on the grip shifter to change gears yourself. The desired gear-changing mode can be selected with a button on the rotary handle.



The display on the rotary handle shows whether the automatic or the manual mode has been selected.

When the manual mode is active, you will see a cyclist on an incline, shown in orange. The easier the gear selected, the further up on the incline the driver will be shown.

Manual operation

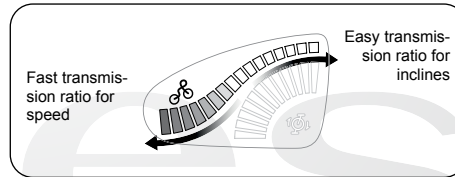

When the automatic mode is active, the rotary handle display will show the symbol of a crank with pedals and a quarter-circle of blue, illuminated elements. The higher the pedalling frequency you selected, the more illuminated elements will be shown.

Automatic mode

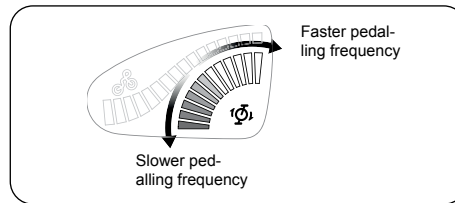

Hub gear shift system

As an alternative, you can have a transmission installed that operates with turning handle. The operating instructions as well as procedure for removing/fitting the system in the case of a puncture are provided in the enclosed operating instructions. It is certainly also helpful if your specialist retailer explains the functionality to you and demonstrates removing/fitting the system.

Twist grip shifter

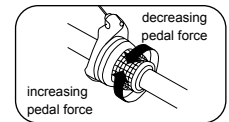
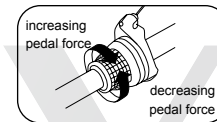

Source: Shimano® techdocs



Your pedelec is supplied with the corresponding operating manual for your specific gear system. You can get more information about the gears on your pedelec in the operating manual provided by your manufacturer or on the manufacturer's website.



Gears are components that are vital to your safety. Please read the enclosed operating instructions supplied by your manufacturer and familiarise yourself with how to operate the pedelec and switch gears before your first ride. Allow your specialist retailer to undertake any work on your pedelec's gears! Work that is improperly carried out is a risk to your safety on the pedelec!



Do not pedal backwards while changing gears as this could damage the gear system. Changes to your gears should only be made in small steps and with the greatest of care. Incorrect setup work can lead to the pedelec chain coming off the sprockets and causing a fall. If you are at all unsure, contact a specialist retailer for help.



Despite a perfectly set up chain gear system, a pedelec chain crossing at an angle can lead to noises during riding. These noises are normal and do not cause any damage to the gear components. With less angled running of the pedelec chain in a different gear, this noise will no longer appear.

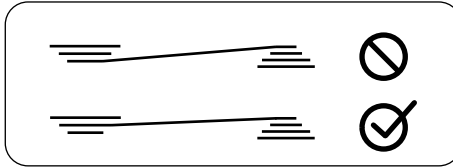

The use of spoke guards is recommended and required for City, Tour and Children's bikes. Otherwise, only minor setup errors could lead to the pedelec chain or the entire rear derailleur falling between the sprockets and the spokes.

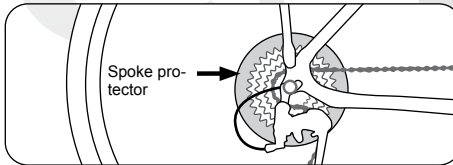

Inspection plan



Only exchange or replace parts of your pedelec with parts of the same brand and type. Otherwise, the guarantee and warranty will be voided.



Modern pedelec technology is highly efficient but sensitive. You should service your pedelec on a regular basis. This requires specialist knowledge and special tools. Have your specialist retailer perform any work on your pedelec! You can get more information about your pedelec's parts as well as cleaning and maintenance in the operating manual provided by your manufacturer or on the manufacturer's website.

Work which you are able to carry out yourself with no risk to safety is printed in bold. Sustainable safe function and retention of warranty claims require that you:

- Clean your pedelec after every ride and check it for possible damage.
- Allow a specialist retailer to carry out inspections.
- Check your pedelec every 300 - 500 km or every three to six months.
- Check that all screws, nuts and quick releases are secure.
- Use a torque wrench to tighten any screws!
- Service and lubricate the movable parts (except the brake surfaces) according to manufacturer information.
- Have paintwork touched up.
- Have deficient and worn parts replaced.

Inspection timeframes and assignments

Before every ride with your pedelec

Check:

- Spokes
- Rims for wear and concentricity
- Tires for damage and foreign bodies
- Quick release
- The functionality of the gears and suspension
- Brake function
- Hydraulic brakes: Tightness
- Lights
- Bell
- Tires: properly secured and correct tire pressure
- Checking the battery is firmly fastened

After riding 200 kilometres from purchase, then at least once a year

Check:

- Tires and wheels

Torques:

- Handlebar
- Seat post
- Chains
- Pedals
- Saddle
- All fastening screws

Adjust the following components:

- Headset
- Gears
- Brakes
- Spring elements

Every 300 to 500 kilometres

Check:

- Pedelec chain or belt drive
- Rear sprocket
- Brake pads for wear, replace if necessary
- Sprocket

Clean:

- Pedelec chain
- Rear sprocket
- Sprocket

Oil:

- Chain with suitable lubricant

Check:

- All screws are firmly fastened

Every 1000 kilometres

- Check hub brakes, grease the brake sleeve with specialist lubricant if required or replace it (specialist retailer)

Every 3000 kilometres

Have the following checked, cleaned or replaced by a specialist retailer:

- Hubs
- Pedals
- Headset
- Gears
- Brakes
- Chain

After riding in wet weather

Clean and oil:

- **Gear system**
- Brakes (excluding brake surfaces)
- Joints in the full suspension frame according to instructions from the manufacturer
- **Chains**

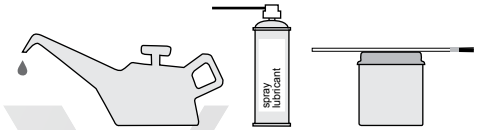

Ask your specialist retailer for suitable lubricants. Not all lubricants are suitable for all purposes. Using the wrong lubricant may lead to damage and reduced functionality!



The first inspection is particularly important for ensuring that your pedelec remains safe and problem-free! Cables and spokes stretch, and bolted connections may come loose. Please always allow a specialist retailer to carry out the first inspection.

Lubricant schedule



Working on the pedelec requires special knowledge, experience and special tools! Only allow experts or specialist pedelec retailers to work or check key parts on the pedelec!

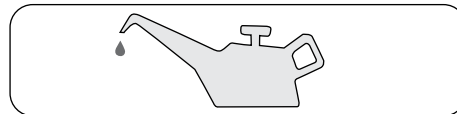

Lubrication plan

What must be lubricated?	At what intervals?	With which lubricant?
Chain	After removing dirt, after having ridden in the rain, every 250 km	Chain oil
Brake and gear cables	When their performance deteriorates, once a year	Silicon-free grease
Wheel bearings, pedal bearings, bottom bracket	Once a year	Bearing grease
Spring elements	After cleaning to remove dirt, after riding in the rain, as prescribed by the manufacturer	Special spraying oil
Thread in case of installation	During installation	Assembly lubricant
Contact surfaces of carbon fibre parts	During installation	Carbon assembly paste
Sliding surfaces of quick releases	Once a year	Grease, spray oil
Metal seat posts in the metal frame	During installation	Grease
Joints of gear systems	When their performance deteriorates, once a year	Spray lubricant
Joints of brake systems	When their performance deteriorates, once a year	Spray lubricant
Joints in the full suspension frame	When their performance deteriorates, when dirty	According to the manufacturer's instructions

Bolted connections



It is vital that all bolted connections on the pedelec have the correct torque in order to ensure that they are secure. Too much tightening torque may damage the screw, nut or component. You must use a torque wrench. You cannot properly tighten the bolted connections without this special tool!



Adhere to any specified torque values where indicated for components. Please read the instructions provided by the manufacturer, which lists the correct mounting torques.

<i>Bolted connection</i>	<i>Torque</i>
Chainset arm, steel	30 Nm
Chainset arm, aluminium	40 Nm
Pedals	40 Nm
Front wheel nut	25 Nm
Rear wheel nut	40 Nm
Stem expander bolts	8 Nm
Ahead stem clamping bolts	9 Nm
Bar-ends – Clamping bolts on the bars	10 Nm

<i>Bolted connection</i>	<i>Torque</i>
M8 bolt for seat post clamp	20 Nm
M6 bolt for seat post clamp	14 Nm
Seat clamp bolt	20 Nm
Brake blocks	6 Nm
Dynamo attachment	10 Nm

Differences for carbon components:

<i>Bolted connection</i>	<i>Torque</i>
Front derailleur bracket attachment screw	3 Nm*
Shift lever attachment screw	3 Nm*
Brake lever attachment screw	3 Nm*
Handlebars - stem clamping	5 Nm*
Stem - fork tube clamping	4 Nm*

<i>Bolted connection</i>	<i>Thread</i>	<i>Torque Max.</i>
Bolt of detachable seat post clamp	M 5	4 Nm*
Bolt of detachable seat post clamp	M 6	5.5 Nm*
Derailleur hanger	M 10 x 1	8 Nm*

<i>Bolted connection</i>	<i>Thread</i>	<i>Torque Max.</i>
Drinking bottle holder	M 5	4 Nm*
Bottom bracket	BSA	according to manufacturer's instructions*
Brake caliper, disk brake, Shimano (IS and PM)	M 6	6 – 8 Nm
Brake caliper, disk brake, AVID (IS and PM)	M 6	8 – 10 Nm
Brake caliper, disk brake, Magura (IS and PM)	M 6	6 Nm

General torques for screw joints

In general, the following torques can be used for bolted connections:

<i>Dimensions</i>	<i>Screw quality</i>			<i>Unit</i>
	8.8	10.9	12.9	
M4	2.7	3.8	4.6	Nm
M5	5.5	8.0	9.5	Nm
M6	9.5	13.0	16.0	Nm
M8	23.0	32.0	39.0	Nm
M10	46.0	64.0	77.0	Nm

* Use of carbon assembly paste is recommended

Loose accessories



You always have to fit the enclosed accessories in line with the guidelines and instructions. You have to ensure that screwed connections are secured with the correct torque (see page 45 "Bolted connections")

- Only use add-on parts which satisfy the requirements of the applicable legal guidelines and road traffic regulations.
- Using unpermitted accessories can result in accidents. You should therefore only use original accessories and add-on parts which fit your pedelec.
- Allow your specialist retailer to advise you.

Loose luggage rack



Only install baggage racks on pedelecs which are suitable for this kind of equipment. Use only the intended fixing devices. Never attach a baggage rack to the seat post! It is not designed for this purpose. Overloading of the seat post by a luggage rack can break the seat post and lead to serious accidents.

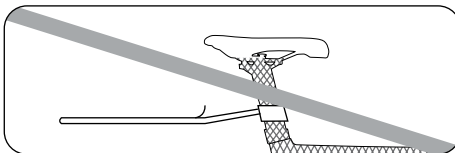

When loading luggage racks, please make sure not to cover the front or rear lights or reflectors!

Avoid uneven loading of the luggage racks.



Not all parts and frames made out of carbon can be combined! Read the manufacturer's manual and ask your specialist retailer.



Bar ends/handlebars

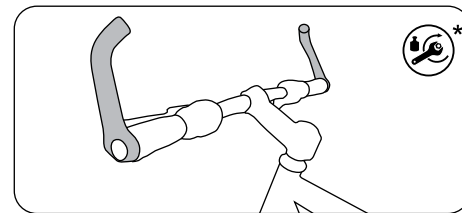

Bar ends always have to be attached to the handlebars with the correct torque, otherwise this can cause falls. Before fitting the bar ends, please inform yourself whether the add-on has been approved by the handlebar manufacturer, as only then may the bar ends be fitted.

Mounted accessories

Accessories / maintenance / spare parts

Lighting system

Your pedelec is fitted with modern lighting technology. In addition to the conventional features, it also offers you safety functions such as a standlight. This means that if you are stationary at night, e.g. at a traffic light, you are still visible to other public road traffic participants. Equally, some models are equipped with the newly developed daytime lights. These are supplied by various energy sources depending on the riding situation. For more on this, please read the instructions supplied by the component manufacturer.



Clean the reflectors and headlights of the lighting system at regular intervals! Warm water and washing up liquid suffice for this job. Keep contact points clean and conductive with a suitable maintenance oil!



Please read the operating instructions supplied for your light system.



If a light is not working properly, the bulb is usually faulty in conventional lights. If you feel confident, you can check this yourself and replace the bulb. Suit-

able bulbs are available from your specialist bicycle/pedelec retailer. It is not possible to replace the bulbs in modern LED lights.



Well-functioning lighting is a matter of life or death! Have them assembled, checked and repaired by a specialist retailer.

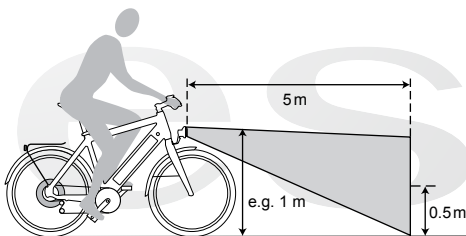

Bike lights

The type of replacement light bulbs depend on the lighting system installed in your pedelec. The following list provides a guide for finding the right bulb.

Lighting used	Bulb information	
Bicycle lights	6 V	2.4 W
Bicycle lights Halogen	6 V	0.6 W
Rear lamp	6 V	0.6 W
Rear light with standlight	6 V	0.6 W

Lighting used

Bulb information

LED lighting

LEDs cannot be replaced

Dynamo

6 V

3 W

Hub dynamo

6 V

3 W

Dynamo

The dynamo generates the required electrical energy for the front headlight and rear lights. Dynamos are often turned on by applying upward pressure to the lever.

The lever for hub dynamos are either located on the back side of the lamp or on the handle bars. If the lighting system is equipped with a sensor, it will turn on and off automatically.

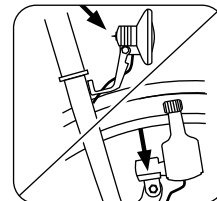

Hub dynamo

If your pedelec uses a hub dynamo, you can switch this on and off easily on the rear side of your front headlight with the on/off switch. The dynamo automatically switches on or off when the lighting system of your pedelec has a light sensor.



In order to remove the front wheel, you first have to remove the connection of the light cable.

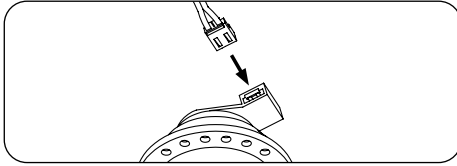

To refit the light cable, the connecting terminal of the hub dynamo has to be fitted on the right (facing forwards). Re-attach the connections correctly and check that the lighting is working properly. To do this, turn the front wheel and check if the light comes on.

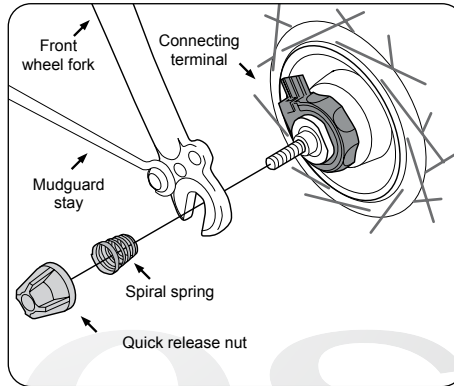
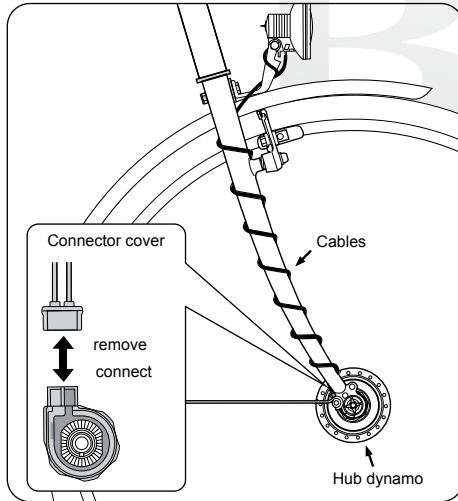

Source: Shimano® techdocs

Lighting system failure



The lighting system is key and it is vital that it is proper working condition. Only have check-up and servicing work done by authorised specialist retailers after failures or temporary problems!

Luggage rack



Luggage load changes the behaviour of your pedelec. It extends the braking distance, among other things. This may lead to severe accidents. Please adjust your riding style to this, i.e. brake earlier and anticipate more sluggish steering. Only transport baggage on racks intended for this purpose! Never attach a baggage rack to the seat post! It is not designed for this purpose. Overloading of the seat post by a luggage rack can break the seat post and lead to serious accidents!

- Only mount child seats on baggage racks if they have the corresponding holders and the manufacturers permit this.
- Please ensure that nothing can get caught in the spokes and spinning wheels.



If you are riding with baggage, ensure that you do not exceed the maximum permissible weight of the pedelec (see page D). Information on the load-bearing capacity of the rack is also stated here.



When loading luggage racks, please make sure not to cover the front or rear lights or reflectors!

Avoid uneven loading of the luggage racks.

Front-wheel luggage carriers



Front racks should be attached to the front axle or the front fork. Front racks have a strong impact on the pedelec's behaviour! Please practice riding with a loaded front rack in a safe area before your first journey!

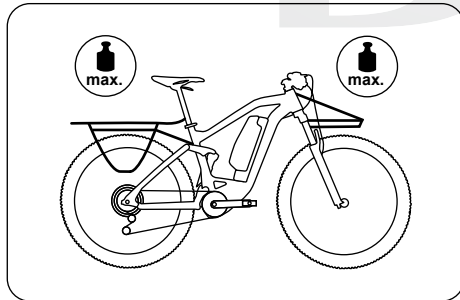

Mudguards

Mudguards are fixed correctly in place with special braces. If the inside of the mudguard runs parallel to the tyre forming a ring shape, the braces are perfectly positioned. During normal use, the mudguard should not loosen. The mudguard is fitted with a safety fastening in case an object jams between the mudguard and the tyre. This releases the mudguard from its holder to prevent a fall.



You must stop cycling immediately if a foreign body is trapped between the tyre and the mudguard. Foreign bodies must be removed before you can continue on your ride. Otherwise, there is a risk of a fall and serious injuries.



On no account should you continue riding with a loose mudguard brace, as this could become wedged in the wheel and jam it.

Damaged mudguards must be replaced by a specialist retailer before riding again. In addition, you should also regularly check whether the braces are fixed securely in the safety releases.

Re-locking a safety release

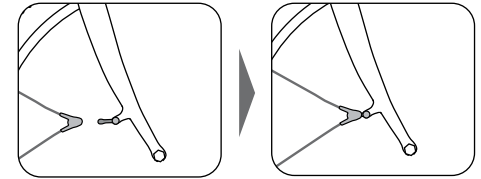

The diagram features a brace attached with a plastic clip.

- This clip is locked into the stay on the fork.
- The mudguards are aligned in such a way that they do not contact the tyres.

Trailer

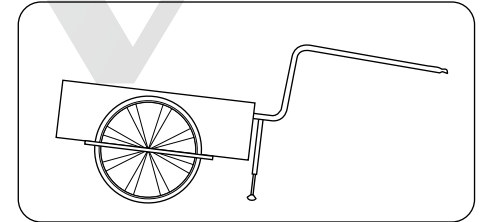

Find out whether your pedelec is approved for use with a trailer. This should have been filled in by your seller on the "Hand-over documentation" page.

Only use trailers that have been approved. Look for a seal of quality like the GS symbol. Ask your specialist retailer for advice, and have the required coupling safely installed by them. Notice that trailers make the pedelec much longer than usual. Riding a pedelec around corners with a trailer is different to riding without. You must keep this in mind when riding in traffic. Before riding on public roads, practise riding your bike with an empty trailer in a safe and quiet environment.



Read the manufacturer's operating manual, which often contains important information regarding riding with a trailer. Please take a look at the corresponding website. Check whether the manufacturer provides a maximum permitted weight and a maximum permitted speed. If so, these values must be adhered to. Children under 16 are not legally permitted to ride a bike with a trailer in Germany.

How to use carbon components



If you have a carbon frame or parts, these should not be applied with grease or oil. Please use special assembly paste for carbon parts.

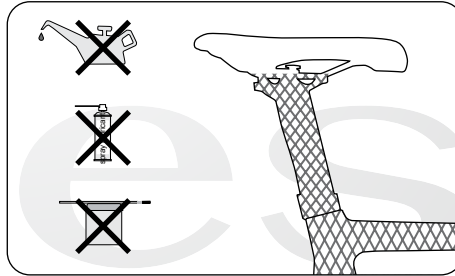

Carbon fibre is a material that requires special handling and care when making the wheel, during servicing, when riding and also during transportation and storage.

Properties of carbon

The term carbon is colloquially used for a composite material consisting of carbon fibres embedded in several layers in a plastic matrix. The material is very light yet highly resilient, but it is susceptible to impacts and dents.



Carbon parts cannot be bent, dented or misshapen after an accident/fall. If this is the case, it is possible that the fibres have been destroyed or have broken off, e.g. within the part, which is not visible from the exterior! Therefore, it is vital to regularly check carbon frames and other carbon components very carefully, especially after a fall or an accident.

- Look for splinters, tears, deep scratches, holes or other changes in the carbon surface.
- Check if the parts have got softer or less stiff than usual.
- Check if individual layers (paint, finish or fibres) come off.
- Listen for any cracking or other usual sounds. If you are not completely certain that your pedelec is in perfect condition, please allow a specialist retailer to check the affected carbon parts!



Some carbon components require lower torques than metal parts. Excessive torques can lead to hidden damage, which is possibly not visible from the outside. Frames or components can break or warp to such an extent that you could fall. Therefore please always adhere to the instructions supplied by the manufacturer or ask for advice from a specialist. Use a torque spanner to ensure that you get the required torque.

Carbon parts may not be applied with grease or oil. Special assembly paste is available for assembling and safely securing carbon components with a low mounting torque.

Never expose carbon parts to high temperatures! Even in the back of cars, the sun's rays can generate such a heat that it can put the safety of carbon parts at risk.

Do not clamp a carbon frame directly into a work stand, instead you should secure it by the seat post. If the seat post is also made of carbon, use another tube made of metal.

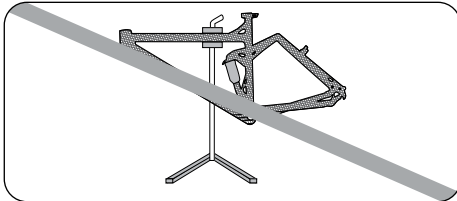

The following components and parts made of carbon should be regularly checked (at least every 100 km) for irregularities such as cracks, breaks or changes to the surface as well as after the pedelec has fallen over or following an accident:

Transition area of the threaded bushing of the bottle cage, slot of the dropouts, bearing areas in full-suspension frame, suspension mounting elements on the main frame and rear suspension, seat clamp, derailleur hanger, derailleur clamp area, disc brake mounting or brake boss, press-fit area of the headset as well as the threads of the bottom bracket cups.

If the parts are made out of composite materials, the rider may not notice any damage. Parts made out of composite materials should either be sent to the manufacturer for inspection or replaced and disposed of in the event of possible damage.

Transporting the Bike

The battery is not considered a hazardous material when transported to operate the pedelec. The battery becomes a hazardous material when it is transported any other way. In this case, you must follow the appropriate guidelines.



Remove the battery of your pedelec/e-bike before transportation and transport it separately.



Never send the battery yourself. Batteries are considered hazardous materials. Only send the battery of your pedelec via your specialist dealer. In some circumstances, it can overheat and catch fire.



By car

You can transport your pedelec by car as you would a normal bicycle. Before transporting your pedelec, remove the battery and transport it separately. The weight of the pedelec will call for a heavier-duty rack. Always adjust your driving behaviour to the load you are carrying.

You should only use roof and rear racks that comply with the requirements of the relevant regulatory authorities. Roof, rear and other racks that are approved by the authorities are safe for use in traffic.

They must have approval in accordance road traffic licensing regulations in your country. Look for a seal of quality like the GS symbol. Inadequate bicycle racks may cause accidents. Always adjust your riding behaviour to the load you are carrying.



The total height of your vehicle changes when you transport a pedelec on the roof!

Carefully attach the pedelec, so that it cannot come detached from the rack. This could result in severe traffic accidents. Check the fasteners multiple times during transport. Loose parts (e.g. tools, air pumps, bags or child seats) may come off during the drive and put other motorists at risk. Remove all loose parts before departing. Only then may the pedelec be attached at the handlebars, stem, pedelec seat or seat post if this is intended by the rack manufacturer. Do not use fasteners that could damage the fork or the frame.



Never attach the pedelec to components made of carbon.

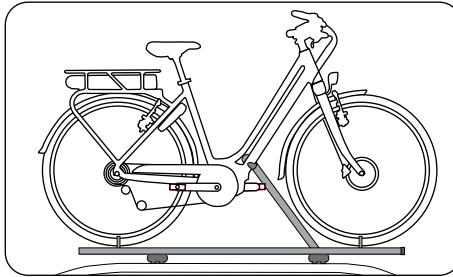

The manufacturers of add-on components and accessories also provide information regarding use and assembly on their websites. Check it out when you use something new.



On the Train

The same regulations apply as when transporting a bicycle. It is best to remove the battery from the bike before and while using public transportation.

Public transportation has different regulations regarding the carrying or transportation of pedelecs. Know which buses and trains you can take before using public transportation.



Aircraft

Batteries must be transported as dangerous goods. You must ensure that it is clearly labelled as such. Ask your airline about this. Also, check with your airline about the regulations regarding the transport of sports equipment/bicycles/pedelecs.

Replacing parts

Guide for parts which may be changed on CE-approved e-bikes / pedelecs with assisted pedalling up to 25 km/h

Category 1

Components allowed to be changed only with permission from the bike's manufacturer/system provider

- **Motor**
- **Sensors**
- **Electrical steering**
- **Electrical cables**
- **Control panel on the handlebars**
- **Display**
- **Battery pack**
- **Charger**

Category 2

Components allowed to be changed only with permission from the bike's manufacturer

- **Frame**
- **Suspension strut**
- **Bike fork and suspension fork**
- **Wheel for the hub motor**
- **Brake system**
- **Brake pads** (rim brakes)
- **Luggage rack**

(Luggage racks determine how much weight the wheel can carry. Both positive and negative changes made to the bike can potentially impact the bike's drivability as compared to that implied by the manufacturer.)

Category 3 *

Components allowed to be changed according to the bike or bike part's manufacturer

- **Pedal crank arm**
(Provided that the distances/chainsets/frame centre (Q-Factor) are observed)
- **Wheel without hub motor**
(Provided that the ETRTO is observed)
- **Chain or drive belt**
(Provided that the original width is observed)
- **Rim tape**
(Use the correct rim tapes for the rims) Modified combinations may result in rim tape shifting and thus in defective inner tubes)
- **Tyres**
(The increased acceleration, additional weight and more dynamic cornering require the use of tyres approved for e-bike use. As a result, compliance with the ETRTO is essential)
- **Brake hoses/brake cables**
- **Brake pads**
(Disc, roller, drum brakes)
- **Handlebar/stem unit**
(Provided that there is no need to change the lengths of cables and/or hoses. It should be possible to change the seating position within the original hose lengths for the benefit of the consumer. Going beyond that results in a significantly changed load distribution on the wheel and could seriously affect steering)
- **Saddle and seat post unit**
(Provided that the offset to the rear does not exceed 20 mm with regard to the series/original area of application. In this case as well, modifying the load distribution beyond the intended adjustment range could seriously affect steering.)

The length of the saddle brace on the saddle frame as well as the saddle shape are also important)

- **Bicycle lights**
(Headlights are designed for a specific voltage which must be compatible with the vehicle's rechargeable batteries. In addition, electromagnetic compatibility (EMC) must be ensured provided that the headlight may be responsible for a part of the potential interference)
- **Sprockets and derailleur cassettes**

*The manufacturer of the part can only approve a component if it was tested in accordance with its intended use and with standards beforehand. A risk analysis must also have been performed.

Category 4

Components not requiring any special kind of approval to be changed

- **Headset bearings**
- **Bottom bracket**
- **Pedals**
(Provided that the pedal is not wider than the series/original area of application)
- **Derailleur**
- **Rear derailleur**
(All gear change parts must be suitable for the number of gears and be compatible with one another)
- **Gear lever/grip shifter**
- **Gear cables and housings**
- **Chain rings/belt pulleys/sprockets**
(Provided that the number of teeth and the diameter is identical to the series/original area of application)

- **Chain guard**
- **Mudguards**
(Provided that the width is not smaller than the series/original parts and the distance to the tyre is at least 10 mm)
- **Spokes**
- **Inner tube of the same type with the same valve**
- **Dynamo**
- **Rear light**
- **Reflector**
- **Spoke reflectors**
- **Bike stand**
- **Grips with screw clamps**
- **Bell**

Category 5

Special notes for mounting accessories

- **Bar ends are permitted**
- **provided that they are mounted on the front**
(The load distribution must not be significantly changed)
- **Rear view mirrors are allowed.**
- **Additional battery/rechargeable battery-operated headlights are permitted in accordance with § 67 StVZO (Germany's Road Traffic Licensing Regulations).**
- **Trailers are only permitted after approval by the vehicle manufacturer.**
- **Child seats are only permitted after approval by the vehicle manufacturer.**
- **Front baskets are not recommended due to the undefined load distribution. Only permitted after approval by the vehicle manufacturer.**

- **Bicycle bags and top cases are permitted. Respect the maximum permissible weight, the maximum load of the rack and the load distribution.**
- **Attached weather protectors are only permitted after approval by the vehicle manufacturer.**
- **Front and rear luggage racks are only permitted after approval by the vehicle manufacturer.**

Source: www.ziv-zweirad.de, Updated on May 08, 2018

Guidelines for replacing parts of e-bikes/pedelecs with pedalling assistance up to 45 km/h

Category 1

Important basic information

- Speed e-bikes with a motor assistance of up to 45 km/h are considered motor vehicles and subject to the EU Directive 2002/24/EC or the EU Regulation No. 168/2013.
- Depending on the vehicle, there may be different requirements which must be strictly observed when replacing a part. Therefore, always check the indications given in the vehicle documents prior to doing any work on the vehicles.
- Note: At present, vehicles with an individual operating licence are mainly subject to the regulations of the EU Directive 2002/24/EC.
- All parts which are not included in the list may only be replaced by original spare parts of the vehicle and/or parts manufacturer

Category 2

Components which may only be replaced upon presentation of a valid test report (parts approval (ABE, EC, ECE) or part certificate*).

- **Brake systems**
- **Brake disks/brake cables/brake pads**
(Only with valid type approval in accordance with ECE-R 90 or general operating licence).
- **Handlebar-stem unit**
(Provided that there is no need to change the lengths of cables and/or hoses. It should be possible to change the seating position within the original hose lengths for the benefit of the consumer. Going beyond that results in a significantly changed load distribution on the pedelec and could seriously affect steering).
- **Seat post**
(Provided that the offset to the rear does not exceed 20 mm with regard to the series/original area of application. It should be noted that modifying the load distribution beyond the intended adjustment range could seriously affect steering. The length of the saddle brace on the saddle frame as well as the saddle shape are also important).
- **Bicycle lights**
(Only with valid type approval, identical mounting position as well as an EMC certificate).
- **Rear light** with brake light and licence plate light if applicable
(Only with valid type approval, identical mounting position as tested in accordance with ECE-R 50 as well as an EMC certificate).
- **Rear reflector**
(Only with valid type approval).

- **Rear-view mirror**
(Only if tested in accordance with ECE-R 81 and with the identical mounting position).
- **Audible warning device (horn)**
(Only if tested in accordance with ECE-R 28 and with the identical mounting position).
- **Pedals**
(Vehicle with 168/2013 approval).

* For components with part certificates, the area of application must be respected. Proper assembly must be certified by a test engineer or a qualified expert.

Category 3

Components which may be replaced under the conditions described below.

- **Pedals**
(Incl. approved reflectors provided it is not wider than the series/original pedal (vehicle with 2002/24/EC approval)).
- **Tyres**
(As specified in vehicle documents, either in accordance with ECE-R 75 or with approval of the tyre manufacturer).
- **Grips with screw clamps**
(In this case, the vehicle width must not be modified).
- **Headset bearings**
- **Bottom bracket**
- **Rear and front derailleurs**
(All gear change parts must be suitable for the number of gears and be compatible with one another).
- **Gear lever/grip shifter**
(Provided that the position on the handlebars remains unchanged).

- **Gear cables and housings**
- **Chain rings/belt pulleys/sprockets**
(Provided that the number of teeth and the diameter is identical to the series/original area of application).
- **Chain guard**
(Provided that it is free of sharp outer edges and complies with the Delegated Regulation (EU) No. 44/2014, Annex VIII).
- **Mudguards**
(Provided that it is free of sharp outer edges and complies with the Delegated Regulation (EU) No. 44/2014, Annex VIII. In addition, the clearance to the tyre, which should be at least 10 mm, must be taken into account).
- **Spokes**
(Provided that the dimensions correspond to the original part).
- **Inner tube**
(Provided that the design and the valve are identical).
- **Chainset**
(Provided that the length and the dimensions, such as chainsets/frame centre (Q-Factor), are observed).
- **Chain/belt**
(Provided that the original width is observed).
- **Rim tape**
(Use the correct rim tapes for the rims) Modified combinations may result in rim tape shift- ing and thus in defective inner tubes).

- **Saddle**
(Provided that the offset to the rear does not exceed 20 mm with regard to the series/original area of application. It should be noted that modifying the load distribution beyond the intended adjustment range could seriously affect steering. The length of the saddle brace on the saddle frame as well as the saddle shape are also important).

Category 4

Special notes for mounting accessories

- Additional battery/rechargeable battery-operated headlights are **not permitted**
- Trailers are only permissible if a trailer load is registered under no. 17 of the certificate of conformity and a coupling device under no. 43.1. Note: The maximum permissible trailer load is 50% of the towing vehicle's unloaded weight (without batteries). There are only 50 mm ball coupling devices available.
- Transporting children in a trailer is in general **prohibited**
- Front baskets are not recommended due to the undefined load distribution. Only permitted after approval by the vehicle manufacturer.
- Bicycle bags without a permanent attachment and top cases are permitted. Respect the maximum permissible weight, the maximum load of the rack and the load distribution.
- Bar ends are not permitted.

Source: www.ziv-zweirad.de, Last updated: 24/05/2018

Warranty and liability in the case of defects



The conditions for guarantee / liability for faults are (partially) harmonised in countries that are subject to EU law. Find out about the relevant national stipulations that apply to you.

Within the scope of EU law, the seller is liable for material faults for at least the first two years from the date of purchase. This includes defects that were present at the time of purchase or handing over. Moreover, during the first six months it is assumed that the fault already existed at the time of purchase.

Pedelecs are complex vehicles. Therefore it is required to implement all service intervals properly. Omitting servicing puts the claim of the seller at risk if the error could have been avoided by servicing. The necessary maintenance is outlined in the chapters of these operating instructions and in the enclosed instructions from the component manufacturers.

Liability for material faults does not cover normal wear and tear within the framework of use as intended. Components of the drive and the braking devices as well as tyres, lights and areas of contact between the rider and the pedelec are subject to wear due to use, as is the battery in the case of pedelecs.

Liability for material faults does not cover normal wear and tear within the framework of use as intended. Construction elements of the propulsion and deceleration devices, as well as tyres, lighting and contact points between the rider and the pedelec are subject to wear and tear by virtue of their function. Contact your specialist dealer if your pedelec's manufacturer entitles you to additional warranty services. Read the relevant guarantee conditions for further details about the guarantee cover and on how to exercise claims under it.



In the case of a defect / possible liability claim, please contact your specialist retailer. We recommend filing all purchase receipts and inspection reports as proof for your records.

Environmental protection tips

General cleaning and maintenance

Please take the environment into account when caring for and cleaning your pedelec. You should use care and cleaning products which are biodegradable wherever possible. Please make sure that no cleaning agents are disposed of in the sewage. When cleaning the chain, use a suitable chain cleaning tool and dispose of chain lubricant properly at a suitable waste disposal site.

Brake cleaners and lubricants

Brake cleaners and lubricants are to be treated like general cleaning and maintenance agents.

Tyres and inner tubes

Tyres and inner tubes may not be put into the residual or domestic waste and have to be disposed of at your local recycling centre.

Pedelec batteries

Batteries belonging to pedelecs should be treated as hazardous and are therefore subject to compulsory special labelling. They have to be disposed of by the retailer or the manufacturer. Contact your specialist dealer.

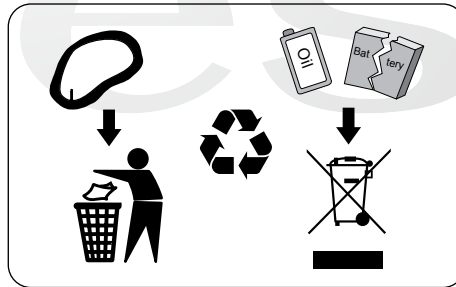

Legal disclosure

For questions about your pedelec, first contact your specialized retailer, then the manufacturer of the product as needed. For contact details, please refer to the warranty section, return envelope or other enclosed brand documentation from the pedelec manufacturer.

Responsible for distributing and marketing the operating instructions:

inMotion mar.com
Rosensteinstr. 22, 70191 Stuttgart,
Germany
info@inmotionmar.com, www.inmotionmar.com

Contents and illustrations:

Veidt-Anleitungen
Friedrich-Ebert-Straße 32
65239 Hochheim, Germany
anleitungen@thomas-veidt.de

Legal inspection by a lawyer's office specialising in intellectual property.

This operating manual covers the requirements and scope of EN 15194:2018-11.

In case of delivery and use outside this scope, the manufacturer of the vehicle must supply the requisite manuals.

© Before reproducing, reprinting, translating or using this document for any commercial purpose (even in part, printed or electronic form), you must first receive written consent.

EPAC EN version 1.6 October 2020

Inspections

During the next inspection special care should be taken for:

Parts that should be changed:

Problems that occurred:

1. Inspection
After approx. 200 kilometres
Work done:

Materials used:

Date, signature

Retailer stamp

2. Inspection
After approx. 1000 kilometres
Work done:

Materials used:

Date, signature

Retailer stamp

3. Inspection
After approx. 2,000 kilometres

Work done:

Materials used:

Date, signature

Retailer stamp

4. Inspection

Work done:

Materials used:

Date, signature

Retailer stamp

5. Inspection

Work done:

Materials used:

Date, signature

Retailer stamp

6. Inspection

Work done:

Materials used:

Date, signature

Retailer stamp

7. Inspection

Work done:

Materials used:

Date, signature

Retailer stamp

8. Inspection

Work done:

Materials used:

Date, signature

Retailer stamp

Hand-over documentation

The pedelec specified in the "vehicle identification" section was delivered to the customer in the following condition:

- A. Fully assembled:** ready to ride
- B. Pre-assembled:** Still to do: Install pedals, straighten, adjust and fix stem, check and adjust tire pressure.
- C. Partly assembled:** Still to do: Tighten the pedals and handlebars with the appropriate tools taking into account the correct torque. This should be carried out by a trained professional or specialist retailer only. Check and adjust tire pressure.

The pedelec corresponds to type _____ according to the chapter "Intended Use".

Functional check for the following components:

- Wheels: spoke tension, sturdiness, concentricity, correct tire pressure
- All screw joints: secure fit, correct tightening torque (see above: "condition on handover")
- Light system Gear system
- Seat position adjusted to the rider Brake system
- Suspension adjusted to the rider
- The following components were assembled and checked separately:

-
- The assembling/inspecting party completed a test ride
 - The customer was instructed on how to use the pedelec
 - Right brake lever operates front brake
 - Left brake lever operates front brake
 - Instruction on how to fix a flat tire, how to open and close the fixtures on the driven wheel

Supplied by (retailer stamp): _____

Date _____ Signature assembly party/retailer _____

The following operating manuals were supplied and explained:

- Pedelec
- Plus:
- Gear system Brake system Suspension elements
 - Belt drive Charger
 - Electric drive system manual Other documentation: _____

Unless otherwise specified, trailers, child seats and racks are not permitted, and the pedelec is not licensed for competitions.

- Permitted for trailers yes no
- Permitted for child seats yes no
- Permitted for luggage racks yes no
- Permitted for competitions yes no
- Authorized for Bike Parks yes no

The maximum permitted weight of the rider including luggage is 100 kg.
The maximum total weight (weight of the pedelec + rider + baggage + trailer) is 125 kg.
Differing from this, a maximum permissible total weight of _____ kg applies (weight of the pedelec + rider + baggage + trailer).
The unloaded weight of the vehicle is ____ kg. If no other value is stated in the empty field, the above-mentioned value of 100 kg applies to the rider including baggage, and 125 kg is the maximum permissible total weight.

Customer/Recipient/Owner

Name _____

Address _____

Postal code, Town/City _____

E-mail _____

Date of purchase _____ Signature recipient/owner _____

Pedelec identification

Pedelec manufacturer _____
Brand _____
Model _____
Frame height/size _____
Colour _____
Frame number _____
Fork/suspension fork _____
Serial number _____
Rear shock absorber _____
Serial number _____
Gear system _____
Engine number _____
Battery number _____
Key number _____
Special features _____

In the case of change of ownership:

Owner _____

Address _____

Date/Signature _____



If the pedelec with which this instruction manual was issued has only been pre-assembled the enclosed assembly instructions must be read and followed. The checks and limitations mentioned above must be carried out and applied by the owner.

Line up this edge when copying

Darfon Europe B.V.

Habraken 2145

5507 TE Veldhoven

The Netherlands

Tel: +31 (0) 403031600

E-Mail: info@besv.com